

Specjalne wykonanie wentylatorów dachowych typu HCTT zgodne z wymogami Dyrektywy 94/9/EC „ATEX” dotyczącej urządzeń przeznaczonych do użytku w przestrzeniach zagrożonych wybuchem.

Dostępne wersje przeciwybuchowe wentylatorów HCTT zgodne z dyrektywą „ATEX”:

- obudowa wzmocniona $\text{II}2\text{G EExelIT}3$
- obudowa ognioszczelna $\text{II}2\text{G EExdIIBT}5$ lub $\text{EExdIICT}4$ (tylko dla modeli HCTT/4-800/, /4-900/, /4-1000/ oraz HCTT/6-800/, /6-900/, /6-1000/).

Wentylatory typu HCTT w wersji przeciwybuchowej są produkowane z silnikami trójfazowymi 230/400V lub 400V, 50Hz, 4-, 6- i 8-biegunowymi. Stopień ochrony IP 55, klasa izolacji F.

Silniki wentylatorów w wersji przeciwybuchowej nie są przystosowane do regulacji prędkości obrotowej.

Wentylatory typu HCTT z silnikami jednofazowymi nie mogą być dostarczone w wykonaniu przeciwybuchowym.

Wszystkie wentylatory typu HCTT w wykonaniu przeciwybuchowym są oznaczone symbolem „EX” występującym w nazwie danego wentylatora, na przykład: HCTT/4-400/-B EX.

Instalację należy przeprowadzić z uwzględnieniem obowiązujących przepisów i warunków określonych w Dokumentacji Techniczno-Ruchowej.

Dla wszystkich modeli oprócz HCTT/4-900 oraz HCTT/4-1000 dedykowany rozłącznik 10A, 3-biegunowy + styk pomocniczy, GHG2610005R0010, nr art.44025761.

Dla modeli HCTT/4-900 oraz HCTT/4-1000 dedykowany rozłącznik 20A, 3-biegunowy + styk pomocniczy, nr art.. 44025762.

Wymiary [mm]

| Typ | ØA | □B | □C | ØD | ØE | F | G | H |
|------|------|------|-----|------|----|----|-----|-----|
| 315 | 640 | 560 | 450 | 315 | 12 | 40 | 70 | 341 |
| 355 | 760 | 630 | 535 | 355 | 12 | 40 | 80 | 361 |
| 400 | 760 | 630 | 535 | 400 | 12 | 40 | 80 | 361 |
| 450 | 895 | 710 | 590 | 450 | 14 | 40 | 110 | 410 |
| 500 | 895 | 710 | 590 | 500 | 14 | 40 | 110 | 410 |
| 560 | 1150 | 905 | 750 | 560 | 14 | 50 | 185 | 488 |
| 630 | 1150 | 905 | 750 | 630 | 14 | 50 | 185 | 488 |
| 710 | 1350 | 1100 | 840 | 710 | 14 | 50 | 200 | 551 |
| 800 | 1350 | 1100 | 840 | 800 | 14 | 50 | 200 | 732 |
| 900 | 1580 | 1250 | 950 | 900 | 14 | 50 | 200 | 756 |
| 1000 | 1580 | 1250 | 950 | 1000 | 14 | 50 | 200 | 756 |

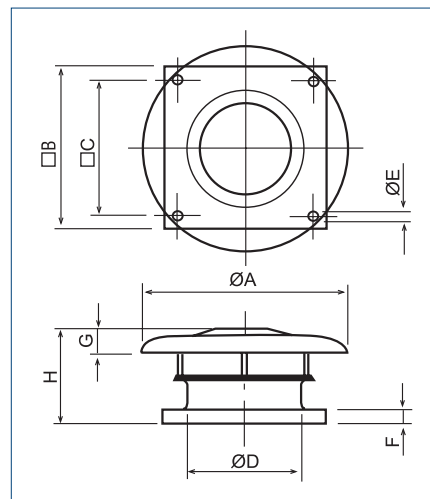

Akcesoria



wyłącznik
3-biegunowy 10A

Dane techniczne dla wentylatorów wywiewnych (typ B)

| Typ | prędkość obrotowa [obr./min] | pobór mocy max. [W] | natężenie max. 400V [A] | wydajność max. [m ³ /h] | poziom ciśnienia akustycznego w odległości 1,5* | | masa [kg] | nr artykułu |
|------------------------|---------------------------------|------------------------|-------------------------------|---------------------------------------|--|------------------|--------------|-------------|
| | | | | | wlot [dB(A)] | wylot [dB(A)] | | |
| TRÓJFAZOWE 4 BIEGUNOWE | | | | | | | | |
| HCTT/4-315-B | 1300 | 150 | 0,34 | 1930 | 59 | 58 | 14,4 | 43525730 |
| HCTT/4-355-B | 1260 | 200 | 0,46 | 2680 | 56 | 55 | 15,8 | 43525740 |
| HCTT/4-400-B | 1350 | 300 | 0,8 | 3700 | 59 | 58 | 16,5 | 43525750 |
| HCTT/4-450-B | 1230 | 500 | 1 | 5600 | 63 | 61 | 23,5 | 43525760 |
| HCTT/4-500-B | 1350 | 660 | 1,6 | 7100 | 69 | 67 | 25,4 | 43525770 |
| HCTT/4-560-B | 1320 | 1210 | 2,3 | 9820 | 73 | 69 | 40 | 43535780 |
| HCTT/4-630-B | 1290 | 1600 | 3,2 | 13000 | 74 | 70 | 42,6 | 43535790 |
| HCTT/4-710-B | 1300 | 2200 | 4 | 18400 | 82 | 80 | 60 | 43535800 |
| HCTT/4-800-B | 1400 | 3 kW** | 7,3 | 23800 | 89 | 86 | 67 | 43535810 |
| HCTT/4-900-B | 1400 | 4 kW** | 9,5 | 30000 | 92 | 89 | 77 | 43525820 |
| HCTT/4-1000-B | 1450 | 5,5 kW** | 12 | 38500 | 93 | 90 | 123 | 43525610 |
| TRÓJFAZOWE 6 BIEGUNOWE | | | | | | | | |
| HCTT/6-450-B | 835 | 190 | 0,48 | 3900 | 53 | 52 | 23,5 | 43525830 |
| HCTT/6-500-B | 830 | 250 | 0,57 | 4600 | 56 | 54 | 25,4 | 43525840 |
| HCTT/6-560-B | 850 | 410 | 0,93 | 6850 | 60 | 58 | 40 | 43525850 |
| HCTT/6-630-B | 810 | 600 | 1,18 | 8400 | 64 | 61 | 42,6 | 43525860 |
| HCTT/6-710-B | 900 | 1100 | 3,3 | 12700 | 72 | 70 | 54 | 43525870 |
| HCTT/6-800-B | 930 | 0,75 kW** | 2,5 | 15800 | 79 | 76 | 57 | 43525880 |
| HCTT/6-900-B | 930 | 1,1 kW** | 3,5 | 20000 | 82 | 79 | 67 | 43525890 |
| HCTT/6-1000-B | 930 | 1,5 kW** | 4,5 | 24700 | 83 | 80 | 108 | 43525900 |
| TRÓJFAZOWE 8 BIEGUNOWE | | | | | | | | |
| HCTT/8-710-B | 670 | 370 | 1,2 | 9500 | 64 | 62 | 52 | 43525910 |
| HCTT/8-800-B | 700 | 370 | 1,9 | 11900 | 71 | 68 | 57 | 43525920 |
| HCTT/8-900-B | 700 | 550 | 2,3 | 15000 | 74 | 71 | 67 | 43525930 |
| HCTT/8-1000-B | 700 | 750 | 2,8 | 18600 | 75 | 72 | 108 | 43525940 |

* Wentylator umieszczony na dachu.

Dane techniczne dla wentylatorów nawiewnych (typ A)

| Typ | prędkość obrotowa [obr./min] | pobór mocy max. [W] | natężenie max. 400V [A] | wydajność max. [m³/h] | poziom ciśnienia akustycznego w odległości 1,5* | | masa [kg] | nr artykułu |
|------------------------|---------------------------------|------------------------|-------------------------------|--------------------------|--|------------------|--------------|-------------|
| | | | | | wlot [dB(A)] | wylot [dB(A)] | | |
| TRÓJFAZOWE 4 BIEGUNOWE | | | | | | | | |
| HCTT/4-315-A | 1360 | 150 | 0,34 | 2150 | 58 | 64 | 14,4 | 43525730-01 |
| HCTT/4-355-A | 1350 | 200 | 0,46 | 3250 | 59 | 61 | 15,8 | 43525740-01 |
| HCTT/4-400-A | 1380 | 300 | 0,8 | 4720 | 64 | 68 | 16,5 | 43525750-01 |
| HCTT/4-450-A | 1350 | 500 | 0,95 | 6670 | 68 | 71 | 23,5 | 43525760-01 |
| HCTT/4-500-A | 1380 | 660 | 1,6 | 8440 | 72 | 76 | 25,4 | 43525770-01 |
| HCTT/4-560-A | 1380 | 1210 | 2,3 | 11400 | 75 | 80 | 40 | 43525780-01 |
| HCTT/4-630-A | 1360 | 1600 | 3 | 15300 | 79 | 84 | 42,6 | 43525790-01 |
| HCTT/4-710-A | 1300 | 2200 | 4 | 20500 | 80 | 85 | 60 | 43525800-01 |
| HCTT/4-800-A | 1400 | 3 kW** | 7,3 | 26600 | 85 | 90 | 67 | 43525810-01 |
| HCTT/4-900-A | 1400 | 4 kW** | 9,5 | 35900 | 88 | 94 | 77 | 43525820-01 |
| HCTT/4-1000-A | 1400 | 5,5 kW** | 12 | 44900 | 89 | 95 | 123 | 43525610-01 |
| TRÓJFAZOWE 6 BIEGUNOWE | | | | | | | | |
| HCTT/6-450-A | 835 | 190 | 0,48 | 4400 | 56 | 60 | 23,5 | 43525830-01 |
| HCTT/6-500-A | 830 | 250 | 0,57 | 5500 | 60 | 63 | 25,4 | 43525840-01 |
| HCTT/6-560-A | 850 | 410 | 0,93 | 7900 | 64 | 68 | 40 | 43525850-01 |
| HCTT/6-630-A | 810 | 600 | 1,18 | 9900 | 66 | 70 | 42,6 | 43525860-01 |
| HCTT/6-710-A | 900 | 1100 | 3,3 | 14200 | 69 | 75 | 54 | 43525870-01 |
| HCTT/6-800-A | 930 | 0,75 kW** | 2,5 | 17700 | 75 | 80 | 57 | 43525880-01 |
| HCTT/6-900-A | 930 | 1,1 kW** | 3,5 | 23800 | 78 | 84 | 67 | 43525890-01 |
| HCTT/6-1000-A | 930 | 1,5 kW** | 4,5 | 28800 | 79 | 85 | 108 | 43525900-01 |
| TRÓJFAZOWE 8 BIEGUNOWE | | | | | | | | |
| HCTT/8-710-A | 670 | 370 | 1,2 | 10600 | 61 | 67 | 52 | 43525910-01 |
| HCTT/8-800-A | 700 | 0,37 kW** | 1,9 | 13300 | 67 | 72 | 57 | 43525920-01 |
| HCTT/8-900-A | 700 | 0,55 kW** | 2,3 | 18000 | 70 | 76 | 67 | 43525930-01 |
| HCTT/8-1000-A | 700 | 0,75 kW** | 2,8 | 21700 | 71 | 77 | 105 | 43525940-01 |

* Wentylator umieszczony na dachu.

Charakterystyka akustyczna

| Wywiew | | 63 | 125 | 250 | 500 | 1000 | 2000 | 4000 | 8000 | |
|-------------|-------|-------|-----|-----|-----|------|------|------|------|----|
| 4-biegunowe | 315 | Wlot | 41 | 57 | 51 | 73 | 64 | 63 | 58 | 51 |
| | | Wylot | 41 | 53 | 54 | 72 | 62 | 60 | 56 | 50 |
| | 355 | Wlot | 45 | 56 | 56 | 60 | 65 | 66 | 63 | 56 |
| | | Wylot | 46 | 56 | 63 | 61 | 63 | 64 | 61 | 54 |
| | 400 | Wlot | 50 | 59 | 58 | 65 | 66 | 69 | 68 | 59 |
| | | Wylot | 51 | 60 | 63 | 65 | 65 | 66 | 66 | 57 |
| | 450 | Wlot | 52 | 60 | 60 | 67 | 72 | 71 | 69 | 61 |
| | | Wylot | 52 | 63 | 64 | 68 | 70 | 70 | 68 | 61 |
| | 500 | Wlot | 55 | 64 | 71 | 74 | 80 | 79 | 74 | 66 |
| | | Wylot | 55 | 65 | 72 | 74 | 76 | 75 | 71 | 64 |
| | 560 | Wlot | 57 | 65 | 75 | 81 | 82 | 81 | 76 | 69 |
| | | Wylot | 57 | 69 | 73 | 76 | 78 | 78 | 75 | 67 |
| | 630 | Wlot | 63 | 70 | 72 | 79 | 83 | 83 | 81 | 73 |
| | | Wylot | 62 | 73 | 75 | 77 | 80 | 78 | 76 | 71 |
| | 710 | Wlot | 71 | 82 | 90 | 89 | 93 | 89 | 82 | 73 |
| | | Wylot | 72 | 86 | 89 | 87 | 89 | 86 | 80 | 72 |
| | 800 | Wlot | 76 | 91 | 96 | 99 | 99 | 95 | 87 | 79 |
| | | Wylot | 77 | 93 | 95 | 94 | 94 | 92 | 86 | 77 |
| 900 | Wlot | 77 | 94 | 98 | 102 | 102 | 98 | 91 | 83 | |
| | Wylot | 77 | 96 | 98 | 97 | 97 | 95 | 89 | 80 | |
| 1000 | Wlot | 76 | 93 | 97 | 103 | 103 | 101 | 94 | 86 | |
| | Wylot | 78 | 94 | 96 | 97 | 100 | 99 | 93 | 85 | |

| | | | | | | | | | | |
|-------------|------|-------|----|----|----|----|----|----|----|----|
| 6-biegunowe | 450 | Wlot | 42 | 48 | 54 | 58 | 62 | 64 | 58 | 50 |
| | | Wylot | 44 | 50 | 56 | 58 | 60 | 61 | 57 | 49 |
| | 500 | Wlot | 45 | 52 | 57 | 60 | 65 | 66 | 62 | 53 |
| | | Wylot | 46 | 53 | 59 | 61 | 63 | 63 | 59 | 52 |
| | 560 | Wlot | 48 | 56 | 62 | 64 | 70 | 70 | 65 | 57 |
| | | Wylot | 49 | 59 | 63 | 64 | 66 | 67 | 63 | 55 |
| | 630 | Wlot | 51 | 57 | 65 | 68 | 73 | 74 | 70 | 60 |
| | | Wylot | 53 | 61 | 66 | 67 | 69 | 70 | 68 | 59 |
| | 710 | Wlot | 61 | 72 | 80 | 79 | 83 | 79 | 72 | 63 |
| | | Wylot | 62 | 76 | 79 | 77 | 79 | 76 | 70 | 62 |
| | 800 | Wlot | 66 | 81 | 86 | 89 | 89 | 85 | 77 | 69 |
| | | Wylot | 67 | 83 | 85 | 84 | 84 | 82 | 76 | 67 |
| | 900 | Wlot | 67 | 84 | 88 | 92 | 92 | 88 | 81 | 73 |
| | | Wylot | 67 | 86 | 88 | 87 | 87 | 85 | 79 | 70 |
| | 1000 | Wlot | 66 | 83 | 87 | 93 | 93 | 91 | 84 | 76 |
| | | Wylot | 68 | 84 | 86 | 87 | 90 | 89 | 83 | 75 |

| Wywiew | | 63 | 125 | 250 | 500 | 1000 | 2000 | 4000 | 8000 | |
|-------------|------|-------|-----|-----|-----|------|------|------|------|----|
| 8-biegunowe | 710 | Wlot | 53 | 64 | 72 | 71 | 75 | 71 | 64 | 55 |
| | | Wylot | 54 | 68 | 71 | 69 | 71 | 68 | 62 | 54 |
| | 800 | Wlot | 58 | 73 | 78 | 81 | 81 | 77 | 69 | 61 |
| | | Wylot | 59 | 75 | 77 | 76 | 76 | 74 | 68 | 59 |
| | 900 | Wlot | 59 | 76 | 80 | 84 | 84 | 80 | 73 | 65 |
| | | Wylot | 59 | 78 | 80 | 79 | 79 | 77 | 71 | 62 |
| | 1000 | Wlot | 58 | 75 | 79 | 85 | 85 | 83 | 76 | 68 |
| | | Wylot | 60 | 76 | 78 | 79 | 82 | 81 | 75 | 67 |

| Nawiew | | 63 | 125 | 250 | 500 | 1000 | 2000 | 4000 | 8000 | |
|-------------|-------|-------|-----|-----|-----|------|------|------|------|----|
| 4-biegunowe | 315 | Wylot | 39 | 61 | 62 | 77 | 68 | 66 | 58 | 52 |
| | | Wlot | 38 | 59 | 65 | 69 | 65 | 60 | 55 | 50 |
| | 355 | Wylot | 41 | 61 | 64 | 69 | 72 | 71 | 64 | 56 |
| | | Wlot | 40 | 62 | 66 | 67 | 69 | 66 | 61 | 52 |
| | 400 | Wylot | 47 | 67 | 71 | 75 | 78 | 76 | 69 | 59 |
| | | Wlot | 46 | 66 | 68 | 72 | 74 | 71 | 65 | 54 |
| | 450 | Wylot | 50 | 71 | 75 | 79 | 82 | 79 | 72 | 64 |
| | | Wlot | 47 | 72 | 72 | 77 | 78 | 73 | 67 | 59 |
| | 500 | Wylot | 57 | 75 | 80 | 84 | 86 | 83 | 76 | 68 |
| | | Wlot | 56 | 74 | 79 | 81 | 82 | 78 | 71 | 65 |
| | 560 | Wylot | 58 | 85 | 84 | 87 | 90 | 87 | 79 | 71 |
| | | Wlot | 58 | 80 | 84 | 82 | 85 | 82 | 75 | 66 |
| | 630 | Wylot | 63 | 86 | 90 | 91 | 94 | 91 | 83 | 73 |
| | | Wlot | 64 | 83 | 89 | 87 | 88 | 85 | 77 | 68 |
| | 710 | Wylot | 73 | 89 | 92 | 93 | 96 | 92 | 84 | 76 |
| | | Wlot | 71 | 88 | 89 | 87 | 88 | 85 | 78 | 70 |
| | 800 | Wylot | 73 | 89 | 95 | 100 | 100 | 97 | 91 | 84 |
| | | Wlot | 70 | 91 | 94 | 94 | 93 | 90 | 83 | 75 |
| 900 | Wylot | 85 | 93 | 99 | 104 | 104 | 101 | 95 | 88 | |
| | Wlot | 73 | 95 | 97 | 97 | 96 | 94 | 88 | 80 | |
| 1000 | Wylot | 78 | 92 | 99 | 104 | 105 | 104 | 98 | 90 | |
| | Wlot | 72 | 94 | 95 | 97 | 99 | 97 | 91 | 83 | |

| | | | | | | | | | | |
|-------------|------|-------|----|----|----|----|----|----|----|----|
| 6-biegunowe | 450 | Wylot | 49 | 60 | 65 | 67 | 70 | 67 | 60 | 52 |
| | | Wlot | 44 | 58 | 66 | 65 | 65 | 62 | 55 | 47 |
| | 500 | Wylot | 54 | 65 | 69 | 71 | 74 | 71 | 62 | 54 |
| | | Wlot | 52 | 63 | 68 | 69 | 69 | 66 | 59 | 50 |
| | 560 | Wylot | 56 | 70 | 74 | 75 | 78 | 75 | 67 | 59 |
| | | Wlot | 54 | 70 | 72 | 71 | 73 | 70 | 63 | 54 |
| | 630 | Wylot | 59 | 73 | 78 | 77 | 80 | 77 | 68 | 59 |
| | | Wlot | 57 | 72 | 76 | 73 | 75 | 72 | 64 | 54 |
| | 710 | Wylot | 63 | 79 | 82 | 83 | 86 | 82 | 74 | 66 |
| | | Wlot | 60 | 77 | 78 | 76 | 77 | 74 | 67 | 59 |
| | 800 | Wylot | 63 | 79 | 85 | 90 | 90 | 87 | 81 | 74 |
| | | Wlot | 60 | 81 | 84 | 84 | 83 | 80 | 73 | 65 |
| | 900 | Wylot | 75 | 83 | 89 | 94 | 94 | 91 | 85 | 78 |
| | | Wlot | 63 | 85 | 87 | 87 | 86 | 84 | 78 | 70 |
| | 1000 | Wylot | 68 | 82 | 89 | 94 | 95 | 94 | 88 | 80 |
| | | Wlot | 62 | 84 | 85 | 87 | 89 | 87 | 81 | 73 |

| Nawiew | | 63 | 125 | 250 | 500 | 1000 | 2000 | 4000 | 8000 | |
|-------------|------|-------|-----|-----|-----|------|------|------|------|----|
| 8-biegunowe | 710 | Wylot | 55 | 71 | 74 | 75 | 78 | 74 | 66 | 58 |
| | | Wlot | 52 | 69 | 70 | 68 | 69 | 66 | 59 | 51 |
| | 800 | Wylot | 55 | 71 | 77 | 82 | 82 | 79 | 73 | 66 |
| | | Wlot | 52 | 73 | 76 | 76 | 75 | 72 | 65 | 57 |
| | 900 | Wylot | 67 | 75 | 81 | 86 | 86 | 83 | 77 | 70 |
| | | Wlot | 55 | 77 | 79 | 79 | 78 | 76 | 70 | 62 |
| | 1000 | Wylot | 60 | 74 | 81 | 86 | 87 | 86 | 80 | 72 |
| | | Wlot | 54 | 76 | 77 | 79 | 81 | 79 | 73 | 65 |

Charakterystyki pracy - wywiew (typ B)

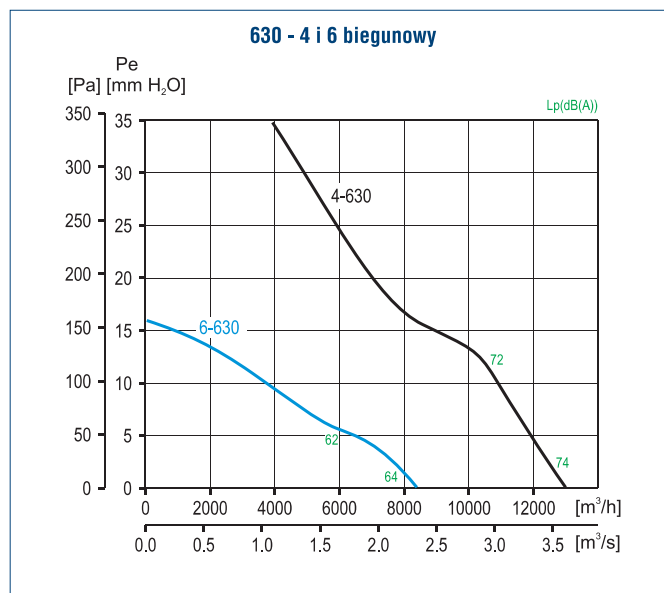
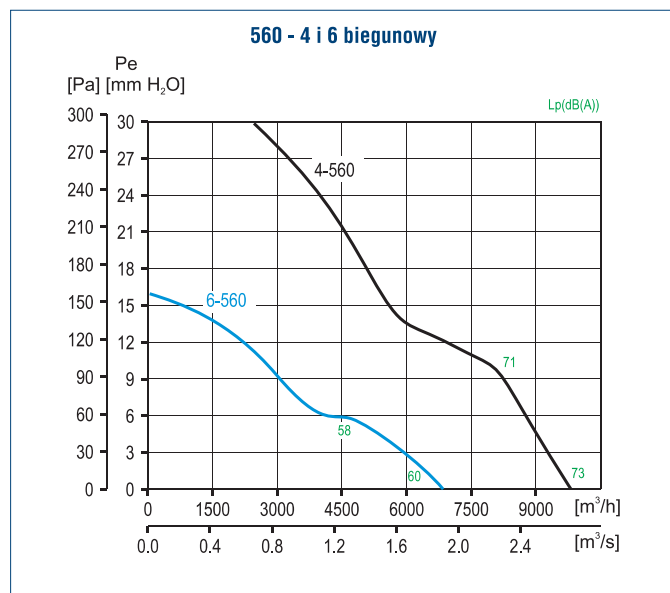
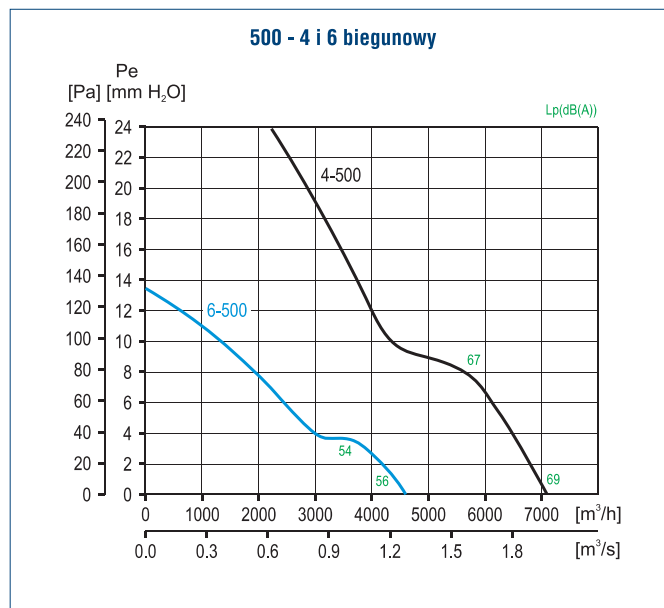
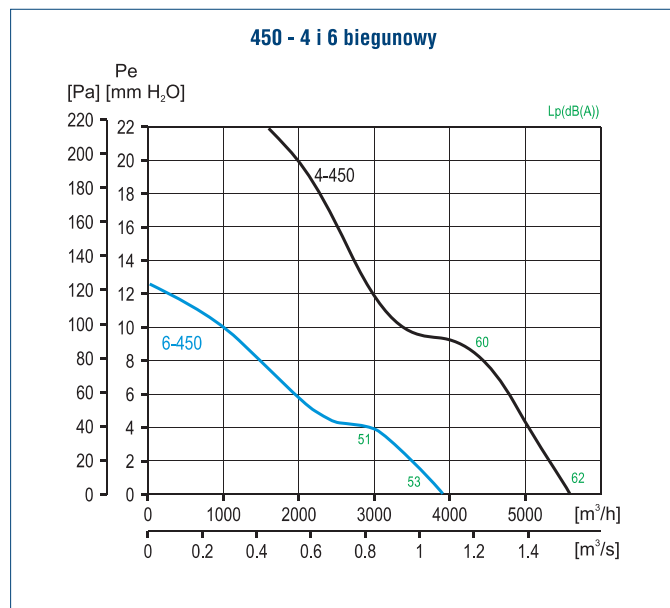
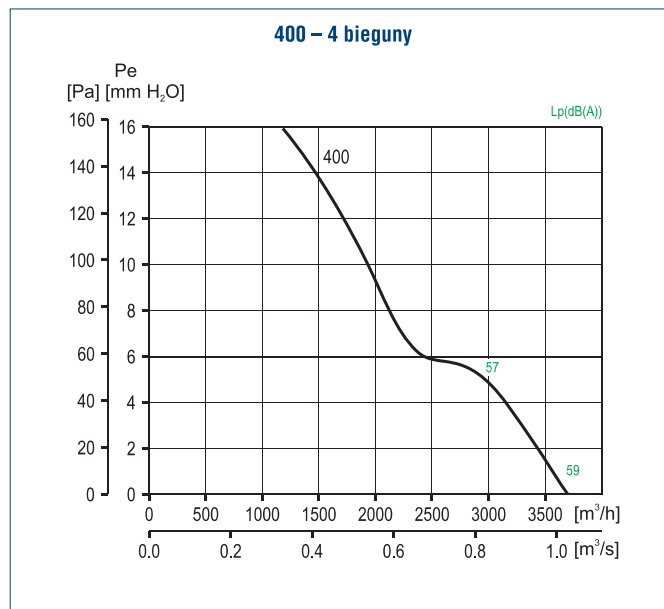
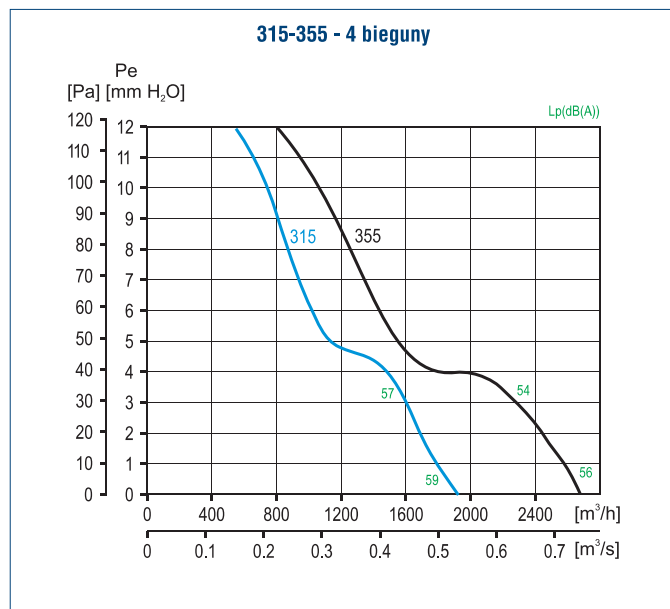

Charakterystyki prac - wywiew (typ B)

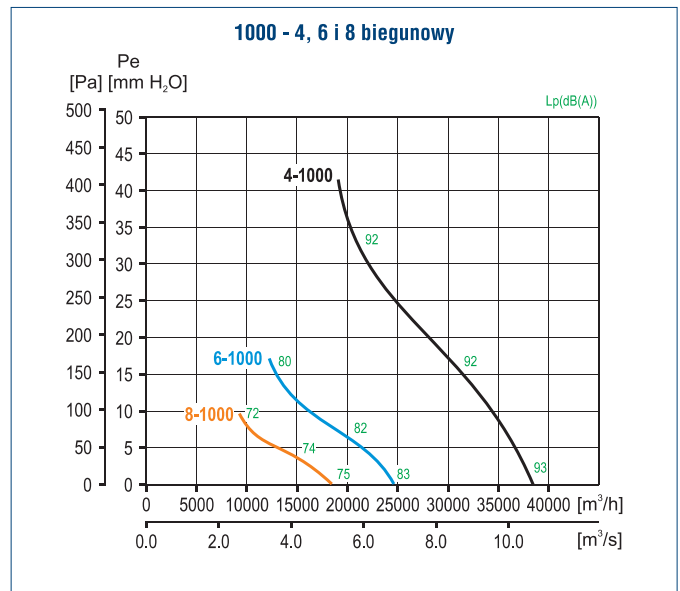
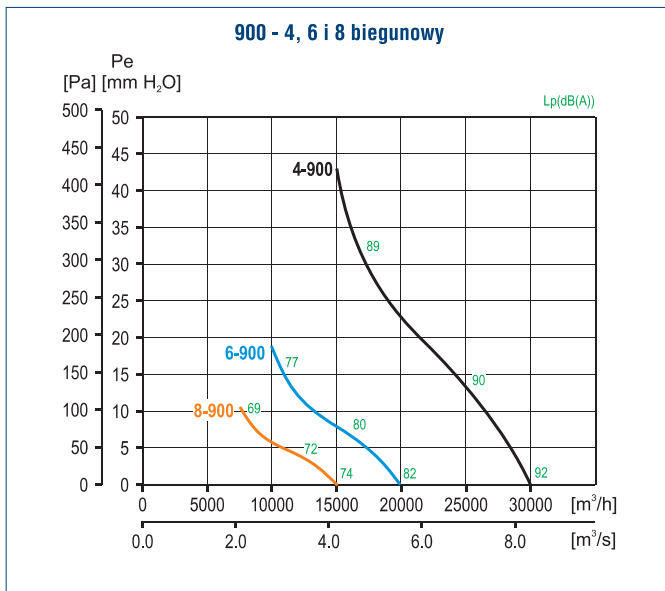
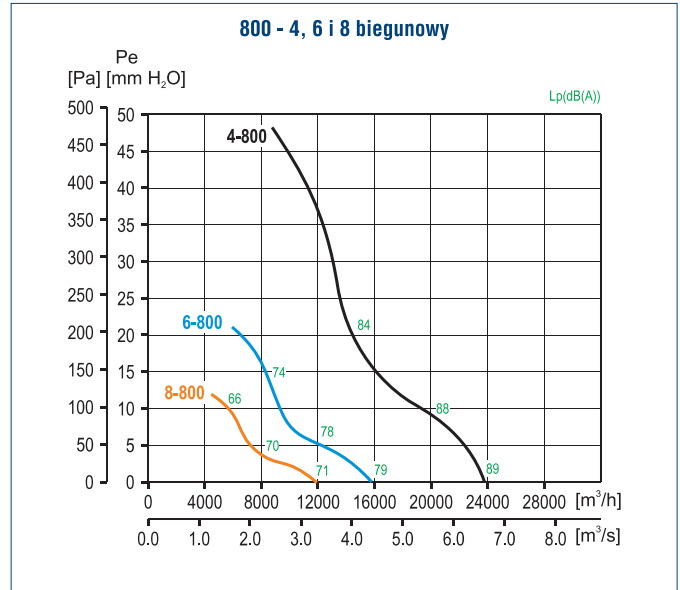
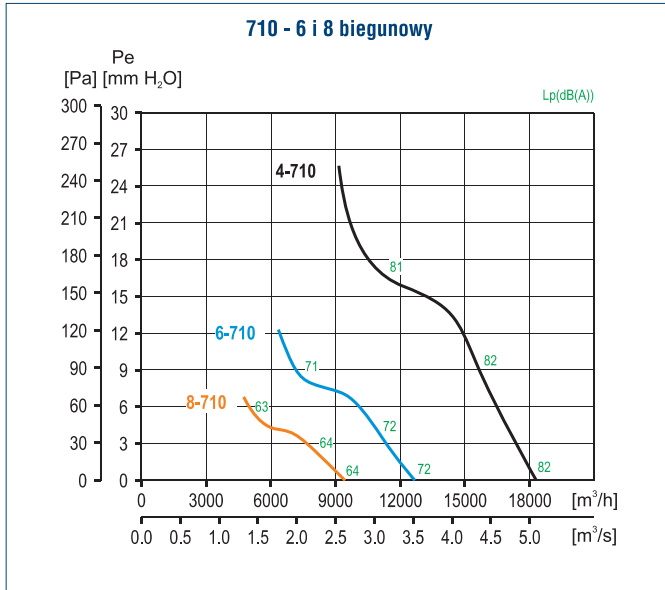

Charakterystyki prac - nawiew (typ A)

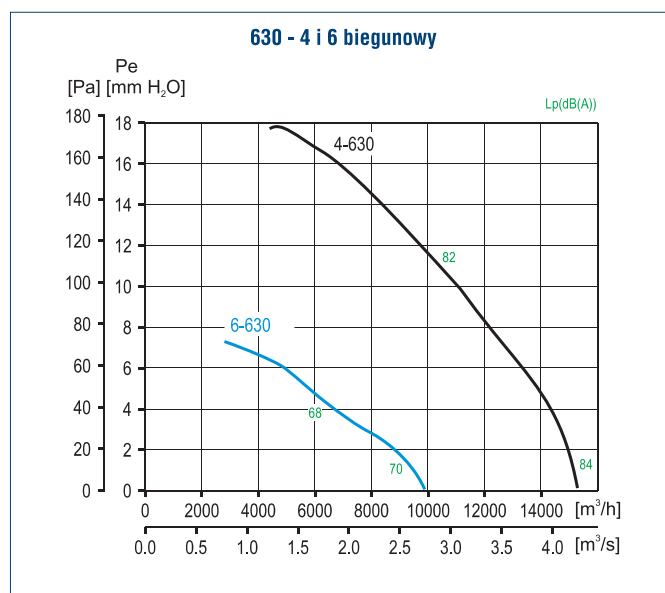
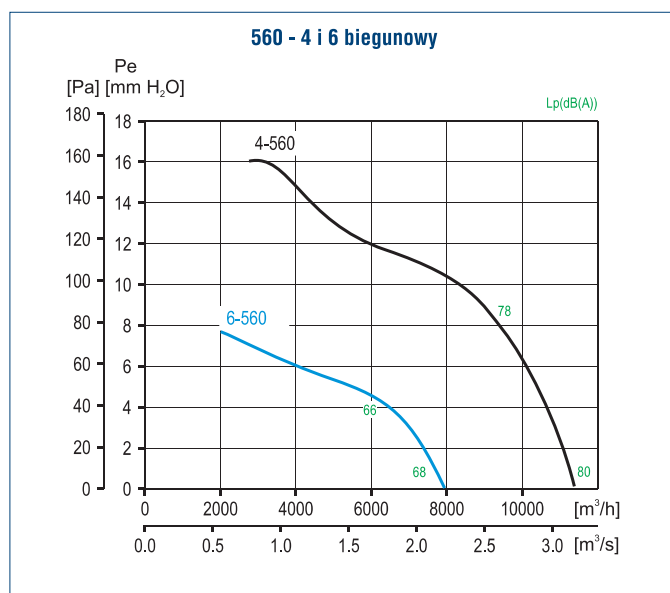
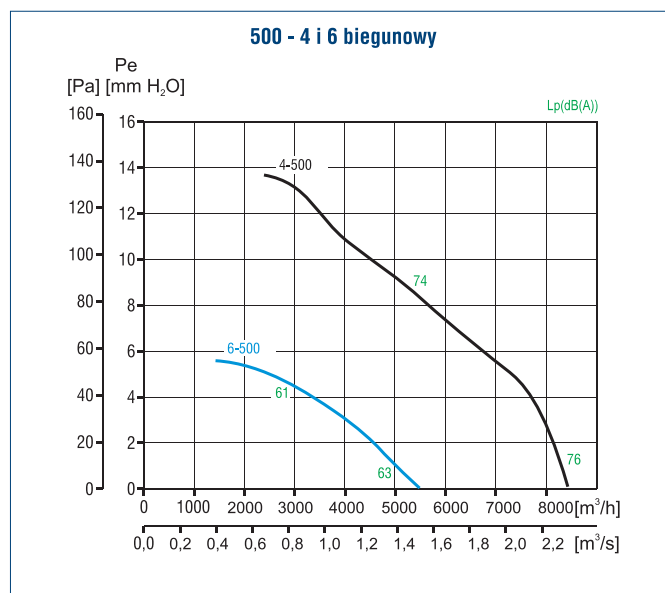
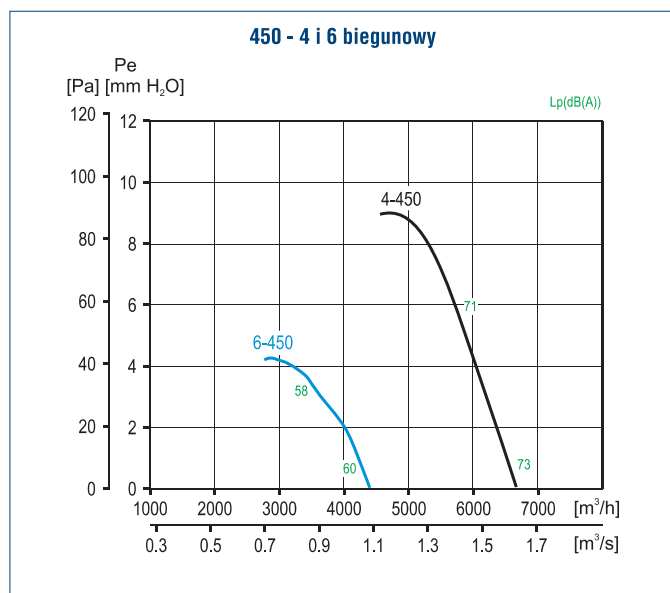
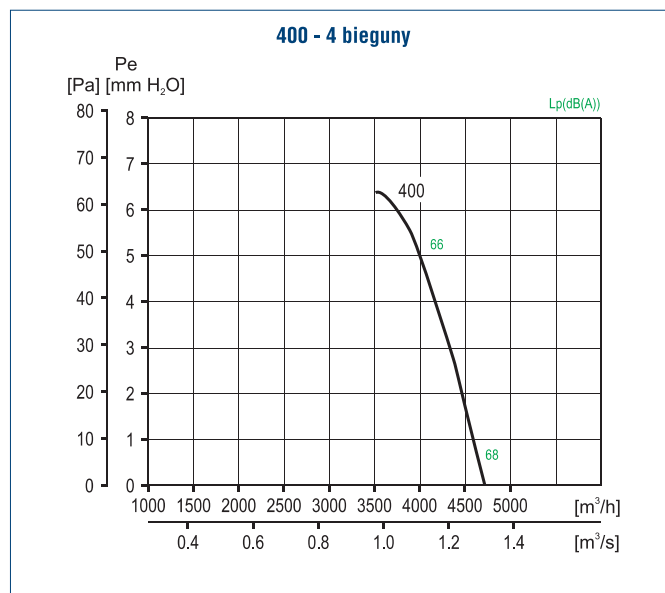
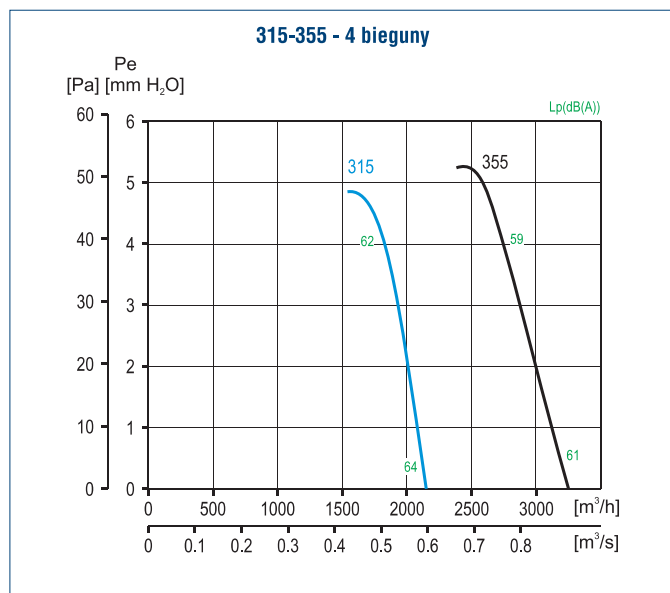

Charakterystyki prac - nawiew (typ A)

