

Zastosowanie

Wentylatory rewersyjne ARC przystosowane są do pracy jako wentylatory nawiewne i wyciągowe, przeznaczone wyłącznie do zastosowań awaryjnych, do pracy krótkotrwałej, z zastrzeżeniem wymagań bezpieczeństwa pożarowego określonych w dyrektywie Rady 89/106/WE. Wersje do innych zastosowań dostępne na życzenie, wymagany kontakt z Działem Technicznym Venture Industries Sp. z o.o. Wentylatory tej serii znajdują zastosowanie w instalacjach wentylacyjnych, gdzie wentylator jest połączony do kanałów od strony wlotu i wylotu. Zwarta i masywna konstrukcja wentylatorów AFC oraz możliwości wykonania wentylatorów w wersjach specjalnych pozwala na szerokie zastosowanie ich w instalacjach wentylacyjnych m.in.:

- ogólna wentylacja lokali handlowych i hal przemysłowych,
- wentylacja magazynów i składów magazynowych,
- wentylacja garaży i budynków użyteczności publicznej etc.

Konstrukcja

Wentylatory osiowe przeznaczone do montażu kanałowego. Obudowy spawane z blachy stalowej malowane na kolor czarny RAL9005. Wirniki standardowo z poliamidu wzmocnianego włóknem szklanym (wielkości od 250 do 710) i aluminiowe (wielkości 1250 i 1500), w wielkościach 800 i 900 z poliamidu lub aluminium w zależności od mocy silnika (4-800 powyżej 3kW aluminiowy, 4-900 powyżej 4kW aluminiowy, 6-800 powyżej 1.5kW aluminiowy, 6-900 powyżej 2.2kW aluminiowy), piasty wirników aluminiowe, wirniki wyważane dynamicznie wg ISO 1940-1. Wentylatory mogą pracować w temperaturze -15°C +40°C. Istnieje możliwość przystosowania lub modyfikacja konstrukcji wg wytycznych odbiorcy.

Wykonania specjalne wymagają uzgodnień z Venture Industries Sp. z o.o.

Silnik elektryczny

Silnik elektryczny wykonany zgodnie z obowiązującymi Dyrektywami oraz klasami sprawności, oznaczony znakiem CE. Klasa Izolacji - F. Stopień ochrony - IP55. Zasilanie - trójfazowe 230/400V 50Hz, 400V 50Hz lub 400/690V 50Hz (w zależności od mocy silnika). Wentylatory z silnikami w innym wykonaniu: tabela wykonań specjalnych.

Schemat podłączenia elektrycznego rys. 8, str. 925.

Oznaczenia

A R C / 2 400 - 150 T DO XXX

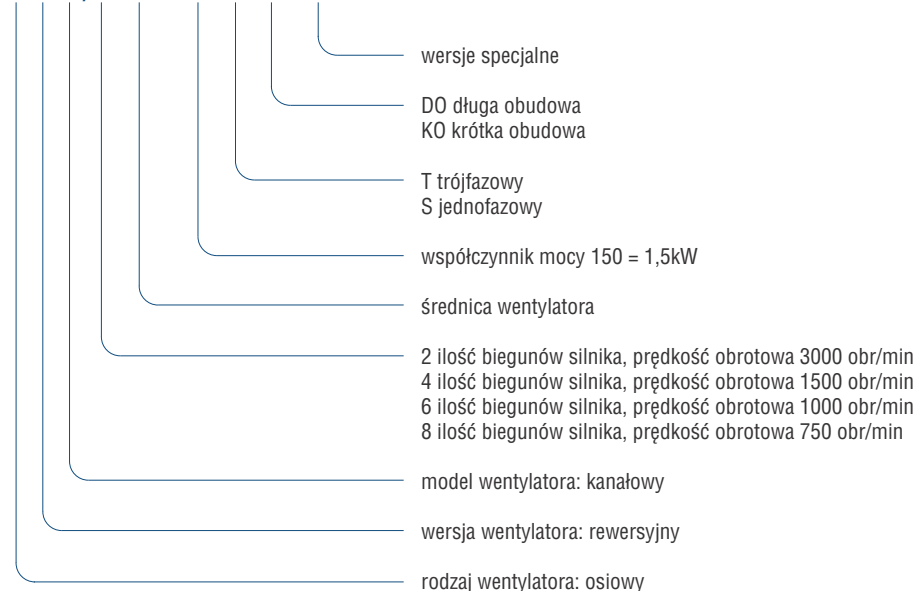

Akcesoria



żaluzje
PER-W
str. 250



żaluzje
PER-CN
str. 251



stopy
montażowe
str. 251



przeciwwłóknierz
str. 252

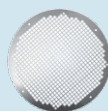

siatka
ochronna
str. 253



złącza p-drg.
AFC
str. 253

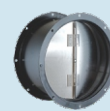

kłapa zwrotna
TSK
str. 252

Dane techniczne

Typ	prędkość obrotowa [obr./min]	moc silnika [kW]	napięcie [V]	natężenie [A]	wydajność [m³/h]	poziom ciśnienia akustycznego [dB(A)] *	nr artykułu
ARC/2-250-012T KO	2800	0,12	230/400	0,35	1500	63	42555005
ARC/2-250-012T DO	2800	0,12	230/400	0,35	1500	63	42555010
ARC/2-250A-018T KO	2760	0,18	230/400	0,55	1750	63	42555015
ARC/2-250A-018T DO	2760	0,18	230/400	0,55	1750	63	42555020
ARC/2-250B-018T KO	2760	0,18	230/400	0,55	2000	64	42555025
ARC/2-250B-018T DO	2760	0,18	230/400	0,55	2000	64	42555030
ARC/2-250C-018T KO	2760	0,18	230/400	0,55	2250	64	42555035
ARC/2-250C-018T DO	2760	0,18	230/400	0,55	2250	64	42555040
ARC/2-250-025T KO	2760	0,25	230/400	0,65	2500	65	42555045
ARC/2-250-025T DO	2760	0,25	230/400	0,65	2500	65	42555050
ARC/4-250A-012T KO	1380	0,12	230/400	0,40	740	49	42555055
ARC/4-250A-012T DO	1380	0,12	230/400	0,40	740	49	42555060
ARC/4-250B-012T KO	1380	0,12	230/400	0,40	870	49	42555065
ARC/4-250B-012T DO	1380	0,12	230/400	0,40	870	49	42555070
ARC/4-250C-012T KO	1380	0,12	230/400	0,40	980	50	42555075
ARC/4-250C-012T DO	1380	0,12	230/400	0,40	980	50	42555080
ARC/4-250D-012T KO	1380	0,12	230/400	0,40	1100	50	42555085
ARC/4-250D-012T DO	1380	0,12	230/400	0,40	1100	50	42555090
ARC/4-250E-012T KO	1380	0,12	230/400	0,40	1200	51	42555095
ARC/4-250E-012T DO	1380	0,12	230/400	0,40	1200	51	42555100
ARC/2-315-025T KO	2760	0,25	230/400	0,65	2800	70	42555105
ARC/2-315-025T DO	2760	0,25	230/400	0,65	2800	70	42555110
ARC/2-315A-037T KO	2800	0,37	230/400	1,0	3300	70	42555115
ARC/2-315A-037T DO	2800	0,37	230/400	1,0	3300	70	42555120
ARC/2-315B-037T KO	2800	0,37	230/400	1,0	3700	71	42555125
ARC/2-315B-037T DO	2800	0,37	230/400	1,0	3700	71	42555130
ARC/2-315A-055T KO	2800	0,55	230/400	1,35	4150	71	42555135
ARC/2-315A-055T DO	2800	0,55	230/400	1,35	4150	71	42555140
ARC/2-315B-055T KO	2800	0,55	230/400	1,35	4500	72	42555145
ARC/2-315B-055T DO	2800	0,55	230/400	1,35	4500	72	42555150
ARC/4-315A-012T KO	1380	0,12	230/400	0,40	1350	55	42555155
ARC/4-315A-012T DO	1380	0,12	230/400	0,40	1350	55	42555160
ARC/4-315B-012T KO	1380	0,12	230/400	0,40	1600	55	42555165
ARC/4-315B-012T DO	1380	0,12	230/400	0,40	1600	55	42555170
ARC/4-315-018T KO	1380	0,18	230/400	0,65	1800	56	42555175
ARC/4-315-018T DO	1380	0,18	230/400	0,65	1800	56	42555180
ARC/4-315A-025T KO	1380	0,25	230/400	0,85	2000	56	42555185
ARC/4-315A-025T DO	1380	0,25	230/400	0,85	2000	56	42555190
ARC/4-315B-025T KO	1380	0,25	230/400	0,85	2200	57	42555195
ARC/4-315B-025T DO	1380	0,25	230/400	0,85	2200	57	42555200
ARC/2-355A-037T KO	2800	0,37	230/400	1,0	3250	70	42555205
ARC/2-355A-037T DO	2800	0,37	230/400	1,0	3250	70	42555210
ARC/2-355B-037T KO	2800	0,37	230/400	1,0	3950	70	42555215
ARC/2-355B-037T DO	2800	0,37	230/400	1,0	3950	70	42555220
ARC/2-355-055T KO	2800	0,55	230/400	1,35	4730	71	42555225
ARC/2-355-055T DO	2800	0,55	230/400	1,35	4730	71	42555230
ARC/2-355A-075T KO	2800	0,75	230/400	1,9	5150	71	42555235
ARC/2-355A-075T DO	2800	0,75	230/400	1,9	5150	71	42555240
ARC/2-355B-075T KO	2800	0,75	230/400	1,9	5850	72	42555245
ARC/2-355B-075T DO	2800	0,75	230/400	1,9	5850	72	42555250
ARC/4-355A-012T KO	1380	0,12	230/400	0,40	1600	56	42555255
ARC/4-355A-012T DO	1380	0,12	230/400	0,40	1600	56	42555260
ARC/4-355B-012T KO	1380	0,12	230/400	0,40	1900	56	42555265
ARC/4-355B-012T DO	1380	0,12	230/400	0,40	1900	56	42555270

Dane techniczne

Typ	prędkość obrotowa [obr./min]	pobór mocy max. [W]	napięcie [V]	natężenie [A]	wydajność max. [m³/h]	poziom ciśnienia akustycznego [dB(A)] *	nr artykułu
ARC/4-355-018T KO	1380	0,18	230/400	0,65	2300	57	42555275
ARC/4-355-018T DO	1380	0,18	230/400	0,65	2300	57	42555280
ARC/4-355-025T KO	1380	0,25	230/400	0,85	2500	57	42555285
ARC/4-355-025T DO	1380	0,25	230/400	0,85	2500	57	42555290
ARC/4-355-037T KO	1370	0,37	230/400	1,25	2850	58	42555295
ARC/4-355-037T DO	1370	0,37	230/400	1,25	2850	58	42555300
ARC/2-400-055T KO	2800	0,55	230/400	1,35	4750	62	42555305
ARC/2-400-055T DO	2800	0,55	230/400	1,35	4750	62	42555310
ARC/2-400-075T KO	2800	0,75	230/400	1,9	5750	63	42555315
ARC/2-400-075T DO	2800	0,75	230/400	1,9	5750	63	42555320
ARC/2-400-110T KO	2780	1,1	230/400	2,5	6700	64	42555325
ARC/2-400-110T DO	2780	1,1	230/400	2,5	6700	64	42555330
ARC/2-400-150T KO	2830	1,5	230/400	3,2	7750	65	42555335
ARC/2-400-150T DO	2830	1,5	230/400	3,2	7750	65	42555340
ARC/4-400A-018T KO	1380	0,18	230/400	0,65	2250	49	42555345
ARC/4-400A-018T DO	1380	0,18	230/400	0,65	2250	49	42555350
ARC/4-400B-018T KO	1380	0,18	230/400	0,65	2750	49	42555355
ARC/4-400B-018T DO	1380	0,18	230/400	0,65	2750	49	42555360
ARC/4-400C-018T KO	1380	0,18	230/400	0,65	3200	50	42555365
ARC/4-400C-018T DO	1380	0,18	230/400	0,65	3200	50	42555370
ARC/4-400-025T KO	1380	0,25	230/400	0,85	3700	50	42555375
ARC/4-400-025T DO	1380	0,25	230/400	0,85	3700	50	42555380
ARC/4-400-037T KO	1370	0,37	230/400	1,25	4150	51	42555385
ARC/4-400-037T DO	1370	0,37	230/400	1,25	4150	51	42555390
ARC/2-450-110T KO	2 780	1.1	230/400	2.5	6 400	71	42555395
ARC/2-450-110T DO	2 780	1.1	230/400	2.5	6 400	71	42555400
ARC/2-450-150T KO	2 835	1.5	230/400	3.2	8 150	72	42555405
ARC/2-450-150T DO	2 835	1.5	230/400	3.2	8 150	72	42555410
ARC/2-450-220T KO	2 850	2.2	230/400	4.7	9 650	72	42555415
ARC/2-450-220T DO	2 850	2.2	230/400	4.7	9 650	72	42555420
ARC/2-450-300T KO	2 900	3.0	230/400	6.1	11 300	73	42555425
ARC/2-450-300T DO	2 900	3.0	230/400	6.1	11 300	73	42555430
ARC/4-450-018T KO	1 380	0,18	230/400	0,65	3 100	58	42555435
ARC/4-450-018T DO	1 380	0,18	230/400	0,65	3 100	58	42555440
ARC/4-450-025T KO	1 380	0,25	230/400	0,85	3 900	58	42555445
ARC/4-450-025T DO	1 380	0,25	230/400	0,85	3 900	58	42555450
ARC/4-450-037T KO	1 370	0,37	230/400	1,25	4 650	59	42555455
ARC/4-450-037T DO	1 370	0,37	230/400	1,25	4 650	59	42555460
ARC/4-450-055T KO	1 400	0,55	230/400	1,60	5 450	59	42555465
ARC/4-450-055T DO	1 400	0,55	230/400	1,60	5 450	59	42555470
ARC/4-450-075T KO	1 390	0,75	230/400	2,1	6 000	60	42555475
ARC/4-450-075T DO	1 390	0,75	230/400	2,1	6 000	60	42555480
ARC/2-500-150T KO	2 835	1.5	230/400	3.2	8 450	74	42555485
ARC/2-500-150T DO	2 835	1.5	230/400	3.2	8 450	74	42555490
ARC/2-500-220T KO	2 850	2.2	230/400	4.7	10 800	75	42555495
ARC/2-500-220T DO	2 850	2.2	230/400	4.7	10 800	75	42555500
ARC/2-500-300T KO	2 900	3.0	230/400	6.1	12 800	76	42555505
ARC/2-500-300T DO	2 900	3.0	230/400	6.1	12 800	76	42555510
ARC/4-500-018T KO	1 380	0,18	230/400	0,65	4 200	59	42555515
ARC/4-500-018T DO	1 380	0,18	230/400	0,65	4 200	59	42555520
ARC/4-500-025T KO	1 380	0,25	230/400	0,85	5 400	60	42555525
ARC/4-500-025T DO	1 380	0,25	230/400	0,85	5 400	60	42555530
ARC/4-500-037T KO	1 370	0,37	230/400	1,25	6 400	61	42555535
ARC/4-500-037T DO	1 370	0,37	230/400	1,25	6 400	61	42555540

Dane techniczne

Typ	prędkość obrotowa [obr./min]	pobór mocy max. [W]	napięcie [V]	natężenie [A]	wydajność max. [m ³ /h]	poziom ciśnienia akustycznego [dB(A)] *	nr artykułu
ARC/4-500-055T KO	1 400	0.55	230/400	1.6	7 550	62	42555545
ARC/4-500-055T DO	1 400	0.55	230/400	1.6	7 550	62	42555550
ARC/4-500-075T KO	1 390	0.75	230/400	2.1	8 500	63	42555555
ARC/4-500-075T DO	1 390	0.75	230/400	2.1	8 500	63	42555560
ARC/4-560-037T KO	1 370	0.37	230/400	1.25	5 490	64	42555565
ARC/4-560-037T DO	1 370	0.37	230/400	1.25	5 490	64	42555570
ARC/4-560-055T KO	1 400	0.55	230/400	1.6	7 050	64	42555575
ARC/4-560-055T DO	1 400	0.55	230/400	1.6	7 050	64	42555580
ARC/4-560-075T KO	1 390	0.75	230/400	2.1	8 600	64	42555585
ARC/4-560-075T DO	1 390	0.75	230/400	2.1	8 600	65	42555590
ARC/4-560-110T KO	1 400	1.1	230/400	2.6	10 200	65	42555595
ARC/4-560-110T DO	1 400	1.1	230/400	2.6	10 200	65	42555600
ARC/4-560-150T KO	1 400	1.5	230/400	3.5	11 600	65	42555605
ARC/4-560-150T DO	1 400	1.5	230/400	3.5	11 600	65	42555610
ARC/6-560-018T KO	890	0.18	230/400	0.75	3 550	55	42555615
ARC/6-560-018T DO	890	0.18	230/400	0.75	3 550	55	42555620
ARC/6-560-025T KO	880	0.25	230/400	1.0	4 600	55	42555625
ARC/6-560-025T DO	880	0.25	230/400	1.0	4 600	55	42555630
ARC/6-560-037T KO	900	0.37	230/400	1.5	5 660	56	42555635
ARC/6-560-037T DO	900	0.37	230/400	1.5	5 660	56	42555640
ARC/6-560-055T KO	900	0.55	230/400	1.75	6 650	56	42555645
ARC/6-560-055T DO	900	0.55	230/400	1.75	6 650	56	42555650
ARC/6-560-075T KO	915	0.75	230/400	2.1	7 600	56	42555655
ARC/6-560-075T DO	915	0.75	230/400	2.1	7 600	56	42555660
ARC/4-630-037T KO	1 370	0.37	230/400	1.25	7 050	68	42555665
ARC/4-630-037T DO	1 370	0.37	230/400	1.25	7 050	68	42555670
ARC/4-630-055T KO	1 400	0.55	230/400	1.6	9 550	68	42555675
ARC/4-630-055T DO	1 400	0.55	230/400	1.6	9 550	68	42555680
ARC/4-630-075T KO	1 390	0.75	230/400	2.1	11 500	68	42555685
ARC/4-630-075T DO	1 390	0.75	230/400	2.1	11 500	68	42555690
ARC/4-630-110T KO	1 400	1.1	230/400	2.6	14 000	69	42555695
ARC/4-630-110T DO	1 400	1.1	230/400	2.6	14 000	69	42555700
ARC/4-630-150T KO	1 400	1.5	230/400	3.5	16 000	69	42555705
ARC/4-630-150T DO	1 400	1.5	230/400	3.5	16 000	69	42555710
ARC/6-630-018T KO	890	0.18	230/400	0.75	4 600	62	42555715
ARC/6-630-018T DO	890	0.18	230/400	0.75	4 600	62	42555720
ARC/6-630-025T KO	880	0.25	230/400	1.0	6 250	62	42555725
ARC/6-630-025T DO	880	0.25	230/400	1.0	6 250	62	42555730
ARC/6-630-037T KO	900	0.37	230/400	1.5	7 500	63	42555735
ARC/6-630-037T DO	900	0.37	230/400	1.5	7 500	63	42555740
ARC/6-630-055T KO	900	0.55	230/400	1.75	9 150	63	42555745
ARC/6-630-055T DO	900	0.55	230/400	1.75	9 150	63	42555750
ARC/6-630-075T KO	915	0.75	230/400	2.1	10 450	63	42555755
ARC/6-630-075T DO	915	0.75	230/400	2.1	10 450	63	42555760
ARC/4-710-055T KO	1 400	0.55	230/400	1.6	8 900	68	42555765
ARC/4-710-055T DO	1 400	0.55	230/400	1.6	8 900	68	42555770
ARC/4-710-075T KO	1 390	0.75	230/400	2.1	12 600	68	42555775
ARC/4-710-075T DO	1 390	0.75	230/400	2.1	12 600	68	42555780
ARC/4-710-110T KO	1 400	1.1	230/400	2.6	16 100	68	42555785
ARC/4-710-110T DO	1 400	1.1	230/400	2.6	16 100	68	42555790
ARC/4-710-150T KO	1 400	1.5	230/400	3.5	19 400	69	42555795
ARC/4-710-150T DO	1 400	1.5	230/400	3.5	19 400	69	42555800
ARC/4-710-220T KO	1 425	2.2	230/400	4.8	22 200	69	42555805
ARC/4-710-220T DO	1 425	2.2	230/400	4.8	22 200	69	42555810

Dane techniczne

Typ	prędkość obrotowa [obr./min]	pobór mocy max. [W]	napięcie [V]	natężenie [A]	wydajność max. [m³/h]	poziom ciśnienia akustycznego [dB(A)] *	nr artykułu
ARC/6-710-025T KO	880	0.25	230/400	1.0	5 850	62	42555815
ARC/6-710-025T DO	880	0.25	230/400	1.0	5 850	62	42555820
ARC/6-710-037T KO	900	0.37	230/400	1.5	8 250	62	42555825
ARC/6-710-037T DO	900	0.37	230/400	1.5	8 250	62	42555830
ARC/6-710-055T KO	900	0.55	230/400	1.75	10 500	63	42555835
ARC/6-710-055T DO	900	0.55	230/400	1.75	10 500	63	42555840
ARC/6-710-075T KO	915	0.75	230/400	2.1	12 700	63	42555845
ARC/6-710-075T DO	915	0.75	230/400	2.1	12 700	63	42555850
ARC/6-710-110T KO	920	1.1	230/400	2.9	14 500	63	42555855
ARC/6-710-110T DO	920	1.1	230/400	2.9	14 500	63	42555860
ARC/4-800-075T KO	1 390	0.75	230/400	2.1	10 800	68	42555865
ARC/4-800-075T DO	1 390	0.75	230/400	2.1	10 800	68	42555870
ARC/4-800-110T KO	1 400	1.1	230/400	2.6	15 300	68	42555875
ARC/4-800-110T DO	1 400	1.1	230/400	2.6	15 300	68	42555880
ARC/4-800-150T KO	1 400	1.5	230/400	3.5	19 700	68	42555885
ARC/4-800-150T DO	1 400	1.5	230/400	3.5	19 700	68	42555890
ARC/4-800-220T KO	1 425	2.2	230/400	4.8	24 600	69	42555895
ARC/4-800-220T DO	1 425	2.2	230/400	4.8	24 600	69	42555900
ARC/4-800-300T KO	1 415	3.0	230/400	6.6	30 000	69	42555905
ARC/4-800-300T DO	1 415	3.0	230/400	6.6	30 000	69	42555910
ARC/4-800-400T KO	1 435	4.0	400V	8.3	29 500	72	42555915
ARC/4-800-400T DO	1 435	4.0	400V	8.3	29 500	72	42555920
ARC/4-800-550T KO	1 450	5.5	400V	11.0	31 500	73	42555925
ARC/4-800-550T DO	1 450	5.5	400V	11.0	31 500	73	42555930
ARC/4-800-750T KO	1 450	7.5	400V	14.6	36 000	74	42555935
ARC/4-800-750T DO	1 450	7.5	400V	14.6	36 000	74	42555940
ARC/6-800-037T KO	900	0.37	230/400	1.5	7 050	62	42555945
ARC/6-800-037T DO	900	0.37	230/400	1.5	7 050	62	42555950
ARC/6-800-055T KO	900	0.55	230/400	1.75	10 000	62	42555955
ARC/6-800-055T DO	900	0.55	230/400	1.75	10 000	62	42555960
ARC/6-800-075T KO	915	0.75	230/400	2.1	12 900	63	42555965
ARC/6-800-075T DO	915	0.75	230/400	2.1	12 900	63	42555970
ARC/6-800-110T KO	920	1.1	230/400	2.9	16 100	63	42555975
ARC/6-800-110T DO	920	1.1	230/400	2.9	16 100	63	42555980
ARC/6-800-150T KO	945	1.5	230/400	3.9	19 650	63	42555985
ARC/6-800-150T DO	945	1.5	230/400	3.9	19 650	63	42555990
ARC/4-900-110T KO	1 400	1.1	230/400	2.6	12 500	70	42555995
ARC/4-900-110T DO	1 400	1.1	230/400	2.6	12 500	70	42556000
ARC/4-900-150T KO	1 400	1.5	230/400	3.5	19 400	70	42556005
ARC/4-900-150T DO	1 400	1.5	230/400	3.5	19 400	70	42556010
ARC/4-900-220T KO	1 425	2.2	230/400	4.8	26 200	70	42556015
ARC/4-900-220T DO	1 425	2.2	230/400	4.8	26 200	70	42556020
ARC/4-900-300T KO	1 415	3.0	230/400	6.6	32 900	71	42556025
ARC/4-900-300T DO	1 415	3.0	230/400	6.6	32 900	71	42556030
ARC/4-900-400T KO	1 435	4.0	400	8.3	39 000	71	42556035
ARC/4-900-400T DO	1 435	4.0	400	8.3	39 000	71	42556040
ARC/4-900-550T KO	1 450	5.5	400V	11.0	36 100	74	42556045
ARC/4-900-550T DO	1 450	5.5	400V	11.0	36 100	74	42556050
ARC/4-900-750T KO	1 450	7.5	400V	14.6	42 400	75	42556055
ARC/4-900-750T DO	1 450	7.5	400V	14.6	42 400	75	42556060
ARC/6-900-055T KO	900	0.55	230/400	1.75	8 150	63	42556065
ARC/6-900-055T DO	900	0.55	230/400	1.75	8 150	63	42556070
ARC/6-900-075T KO	915	0.75	230/400	2.1	12 700	63	42556075
ARC/6-900-075T DO	915	0.75	230/400	2.1	12 700	63	42556080

Dane techniczne

Typ	prędkość obrotowa [obr./min]	pobór mocy max. [W]	napięcie [V]	natężenie [A]	wydajność max. [m ³ /h]	poziom ciśnienia akustycznego [dB(A)] *	nr artykułu
ARC/6-900-110T KO	920	1.1	230/400	2.9	17 150	64	42556085
ARC/6-900-110T DO	920	1.1	230/400	2.9	17 150	64	42556090
ARC/6-900-150T KO	945	1.5	230/400	3.9	21 550	64	42556095
ARC/6-900-150T DO	945	1.5	230/400	3.9	21 550	64	42556100
ARC/6-900-220T KO	960	2.2	230/400	4.8	25 550	64	42556105
ARC/6-900-220T DO	960	2.2	230/400	4.8	25 550	64	42556110
ARC/4-1000-300T KO	1 415	3.0	230/400	6.6	17 800	76	42556115
ARC/4-1000-300T DO	1 415	3.0	230/400	6.6	17 800	76	42556120
ARC/4-1000-400T KO	1 435	4.0	230/400	8.3	27 900	76	42556125
ARC/4-1000-400T DO	1 435	4.0	230/400	8.3	27 900	76	42556130
ARC/4-1000-550T KO	1 450	5.5	400	11.0	36 900	77	42556135
ARC/4-1000-550T DO	1 450	5.5	400	11.0	36 900	77	42556140
ARC/4-1000-750T KO	1 450	7.5	400	14.6	45 800	78	42556145
ARC/4-1000-750T DO	1 450	7.5	400	14.6	45 800	78	42556150
ARC/4-1000-1100T KO	1 460	11.0	400	21	55 100	78	42556155
ARC/4-1000-1100T DO	1 460	11.0	400	21	55 100	78	42556160
ARC/4-1000-1500T KO	1 460	15.0	400	27.7	65 500	80	42556165
ARC/4-1000-1500T DO	1 460	15.0	400	27.7	65 500	80	42556170
ARC/6-1000-075T KO	915	0.75	230/400	2.1	11 650	68	42556175
ARC/6-1000-075T DO	915	0.75	230/400	2.1	11 650	68	42556180
ARC/6-1000-110T KO	920	1.1	230/400	2.9	18 250	68	42556185
ARC/6-1000-110T DO	920	1.1	230/400	2.9	18 250	68	42556190
ARC/6-1000-150T KO	945	1.5	230/400	3.9	24 150	69	42556195
ARC/6-1000-150T DO	945	1.5	230/400	3.9	24 150	69	42556200
ARC/6-1000-220T KO	960	2.2	230/400	4.8	30 000	70	42556205
ARC/6-1000-220T DO	960	2.2	230/400	4.8	30 000	70	42556210
ARC/6-1000-300T KO	950	3.0	230/400	6.8	36 100	70	42556215
ARC/6-1000-300T DO	950	3.0	230/400	6.8	36 100	70	42556220
ARC/4-1250-1100T KO	1 460	11.0	400	21	57 700	84	42556225
ARC/4-1250-1100T DO	1 460	11.0	400	21	57 700	84	42556230
ARC/4-1250-1500T KO	1 460	15.0	400	27.7	75 100	84	42556235
ARC/4-1250-1500T DO	1 460	15.0	400	27.7	75 100	84	42556240
ARC/4-1250-2200T KO	1 465	22.0	400	39	93 100	85	42556245
ARC/4-1250-2200T DO	1 465	22.0	400	39	93 100	85	42556250
ARC/4-1250-3000T KO	1 472	30.0	400	56	110 000	86	42556255
ARC/4-1250-3000T DO	1 472	30.0	400	56	110 000	86	42556260
ARC/4-1250-3700T KO	1 475	37.0	400	66	124 000	86	42556265
ARC/4-1250-3700T DO	1 475	37.0	400	66	124 000	86	42556270
ARC/6-1250-300T KO	950	3.0	230/400	6.8	37 800	76	42556275
ARC/6-1250-300T DO	950	3.0	230/400	6.8	37 800	76	42556280
ARC/6-1250-400T KO	950	4.0	400	8.6	49 200	76	42556285
ARC/6-1250-400T DO	950	4.0	400	8.6	49 200	76	42556290
ARC/6-1250-550T KO	950	5.5	400	11.8	61 000	77	42556295
ARC/6-1250-550T DO	950	5.5	400	11.8	61 000	77	42556300
ARC/6-1250-750T KO	960	7.5	400	15.2	72 000	78	42556305
ARC/6-1250-750T DO	960	7.5	400	15.2	72 000	78	42556310
ARC/6-1250-1100T KO	960	11.0	400	22.0	81 200	79	42556315
ARC/6-1250-1100T DO	960	11.0	400	22.0	81 200	79	42556320
ARC/6-1500A-1500T KO	960	11.0	400	22.0	60 000	89	42556325
ARC/6-1500A-1500T DO	960	11.0	400	22.0	60 000	89	42556330
ARC/6-1500B-1500T KO	975	15.0	400	29.0	80 000	90	42556335
ARC/6-1500B-1500T DO	975	15.0	400	29.0	80 000	90	42556340
ARC/6-1500-2200T KO	980	22.0	400	40.0	99 000	91	42556345
ARC/6-1500-2200T DO	980	22.0	400	40.0	99 000	91	42556350

Dane techniczne

Typ	prędkość obrotowa [obr./min]	moc silnika [kW]	napięcie [V]	natężenie [A]	wydajność [m³/h]	poziom ciśnienia akustycznego [dB(A)] *	nr artykułu
ARC/6-1500-3000T KO	980	30.0	400	54	119 000	92	42556355
ARC/6-1500-3000T DO	980	30.0	400	54	119 000	92	42556360
ARC/6-1500-3700T KO	985	37.0	400	65	135 000	93	42556365
ARC/6-1500-3700T DO	985	37.0	400	65	135 000	93	42556370
ARC/8-1500-550T KO	700	5.5	400	12.7	44 800	79	42556375
ARC/8-1500-550T DO	700	5.5	400	12.7	44 800	79	42556380
ARC/8-1500-750T KO	700	7.5	400	16.3	59 700	80	42556385
ARC/8-1500-750T DO	700	7.5	400	16.3	59 700	80	42556390
ARC/8-1500-1100T KO	730	11.0	400	24	74 000	81	42556395
ARC/8-1500-1100T DO	730	11.0	400	24	74 000	81	42556400
ARC/8-1500-1500T KO	730	15.0	400	30	88 500	81	42556405
ARC/8-1500-1500T DO	730	15.0	400	30	88 500	81	42556410
ARC/8-1500-1850T KO	730	18.5	400	37	100 000	82	42556415
ARC/8-1500-1850T DO	730	18.5	400	37	100 000	82	42556420

* Dane w odległości 3m od wentylatora, przy zabudowanej instalacji na wlocie i wylocie wentylatora.

Wymiary

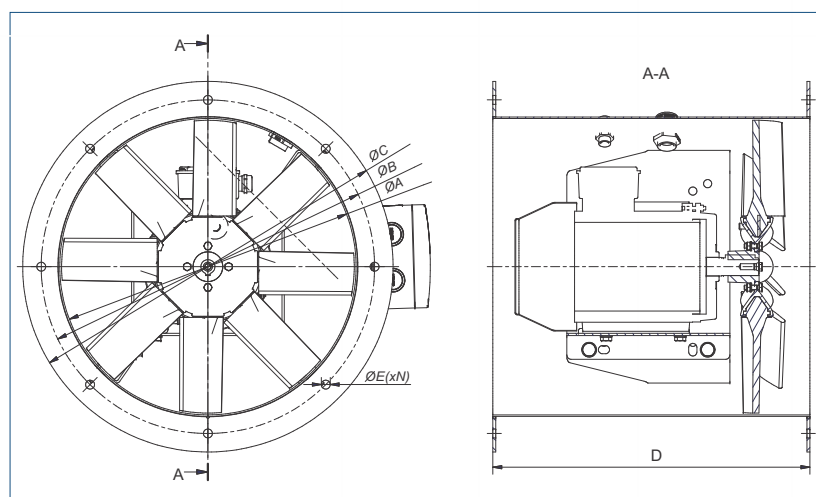

wielkość	A	B	C	D		E	ilość otworów
				KO	DO		
250	250	292	327	150	360	10	4
315	315	355	386	150	360	10	8
350	350	395	426	200	400	10	8
400	400	450	487	250	450	12	8
450	450	500	537	250	450	12	8
500	500	560	595	300	500	12	12
560	560	620	655	300	550	12	12
630	630	690	725	400	550	12	12
710	710	770	806	400	550	12	16
800	800	860	896	400	800	16	12
900	900	950	1000	400	800	12	12
1000	1000	1100	1100	450	850	12	12
1250	1250	1350	1400	450	900	12	16
1500	1500	1580	1650	500	1000	16	24

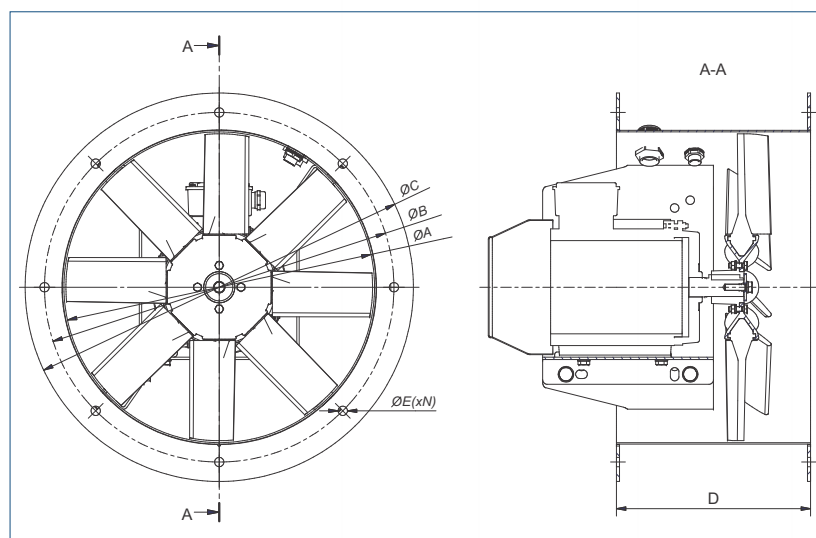

Charakterystyki pracy

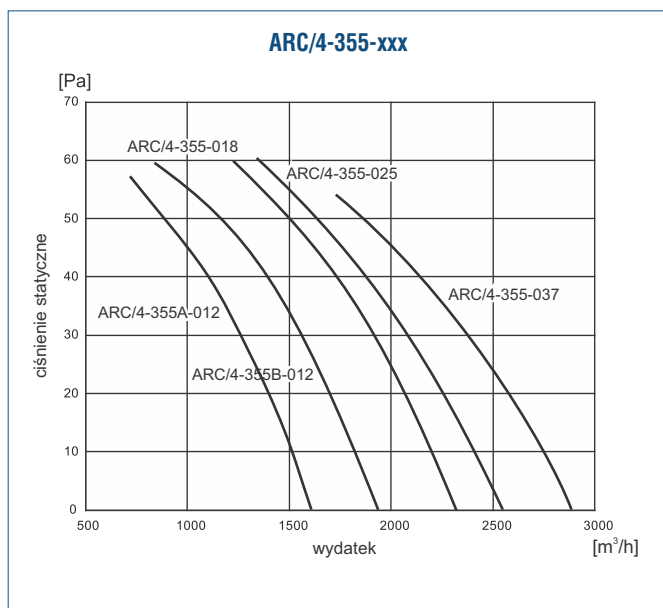
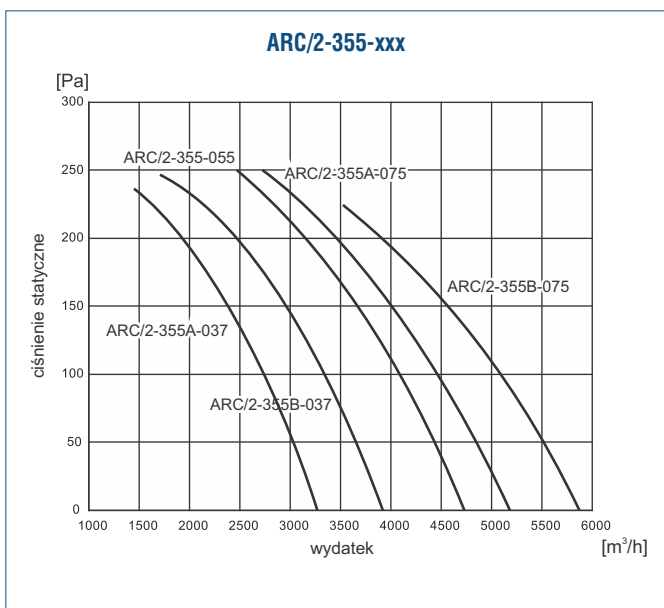
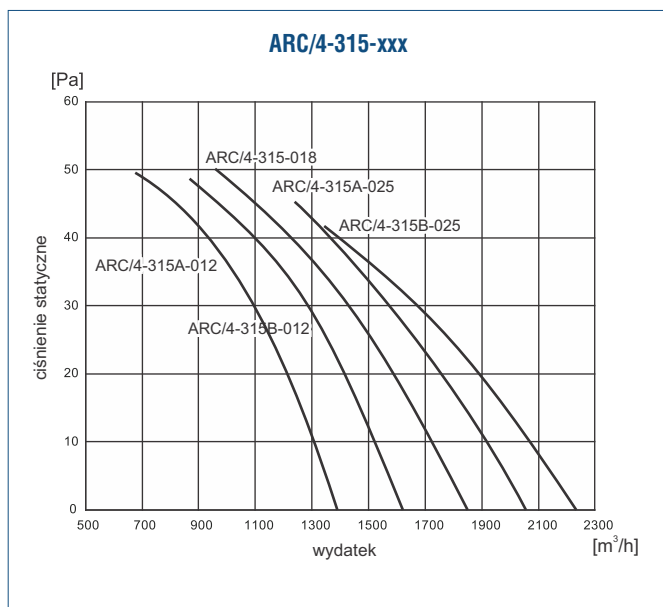
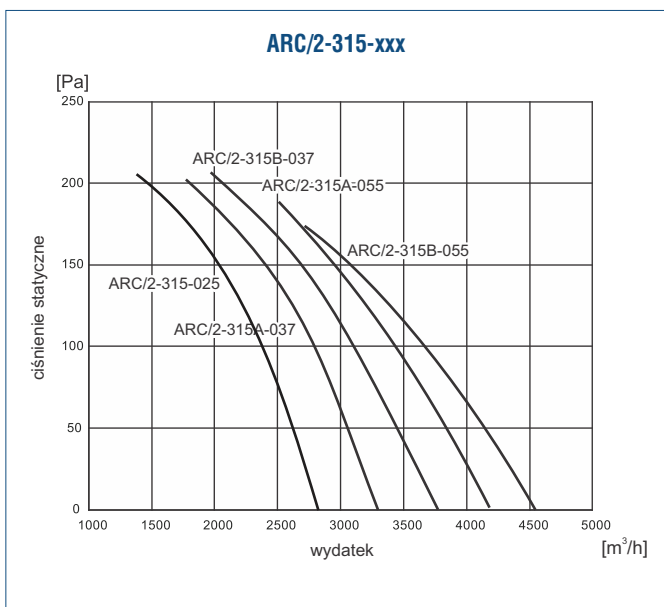
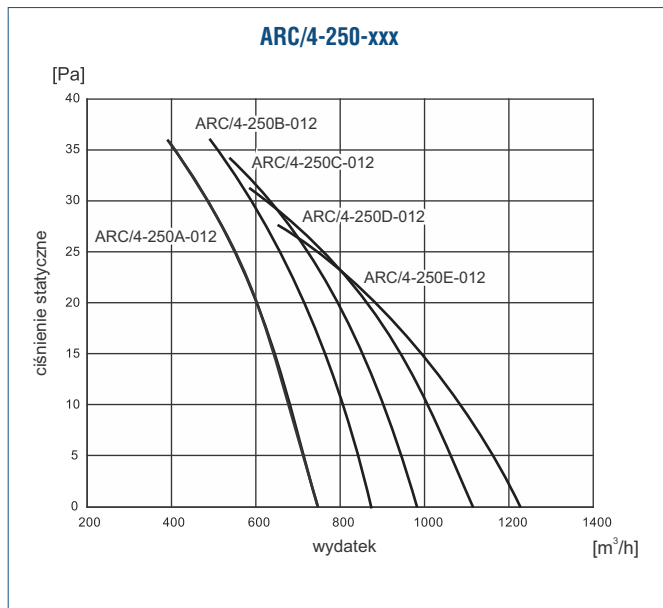
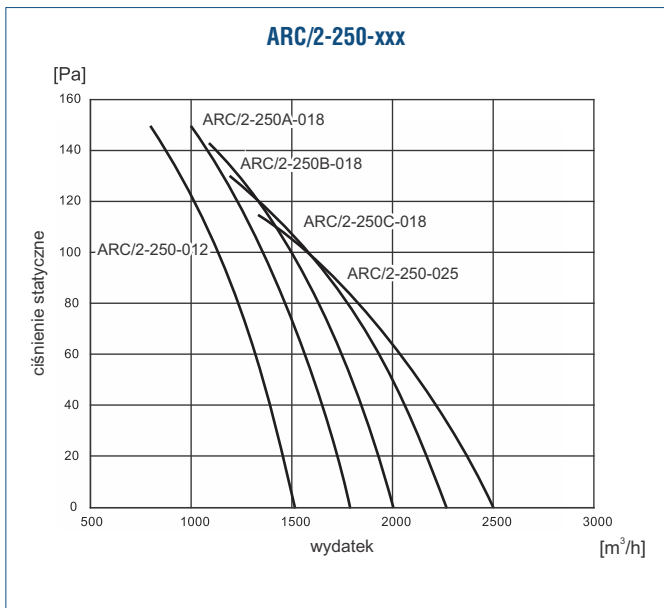

Charakterystyki pracy

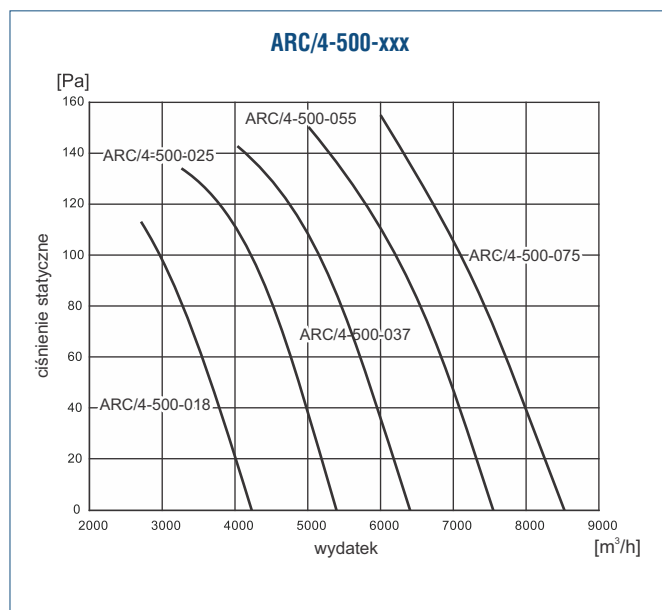
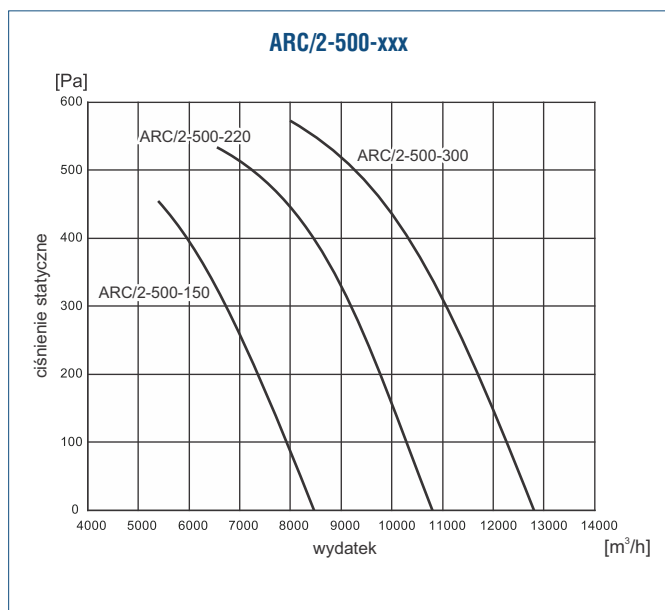
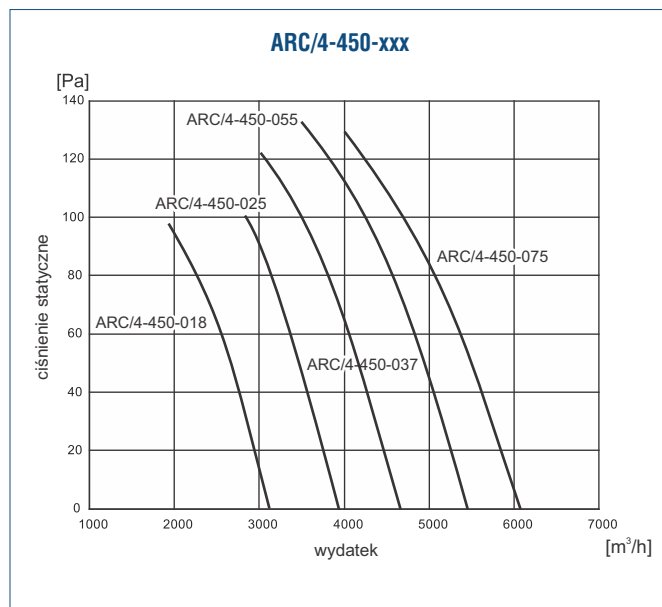
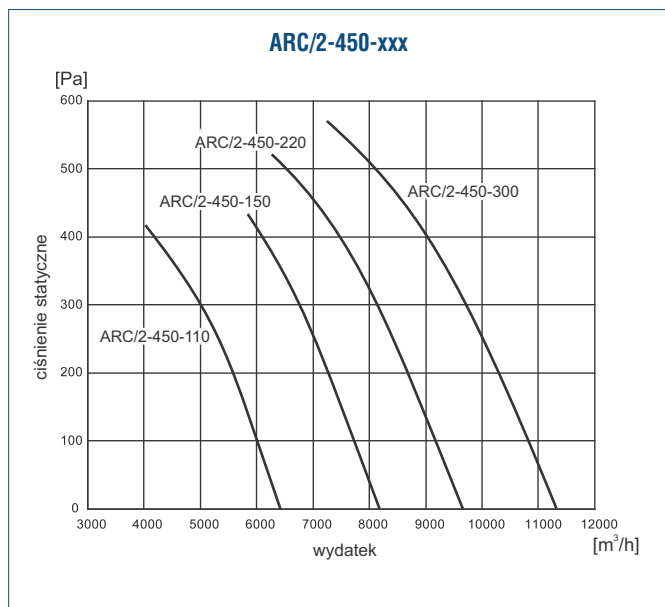
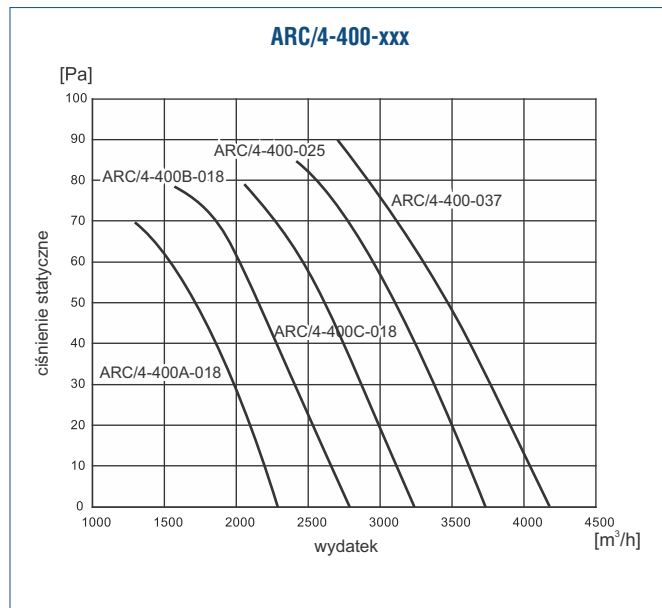
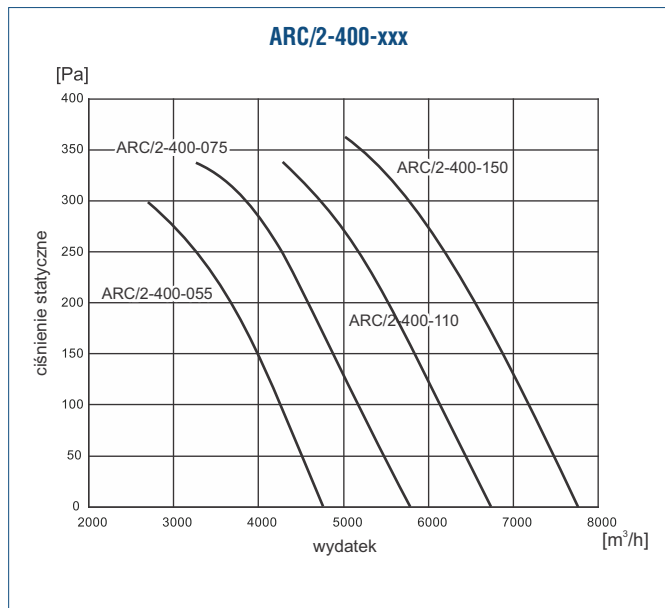

Charakterystyki pracy

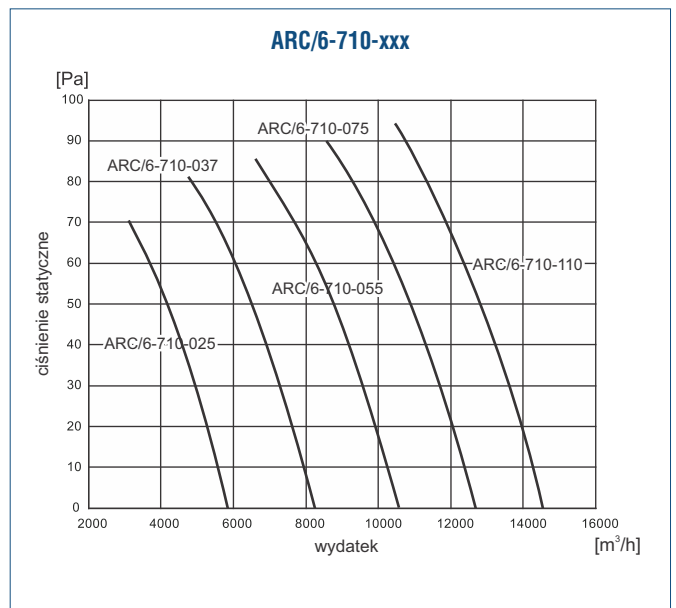
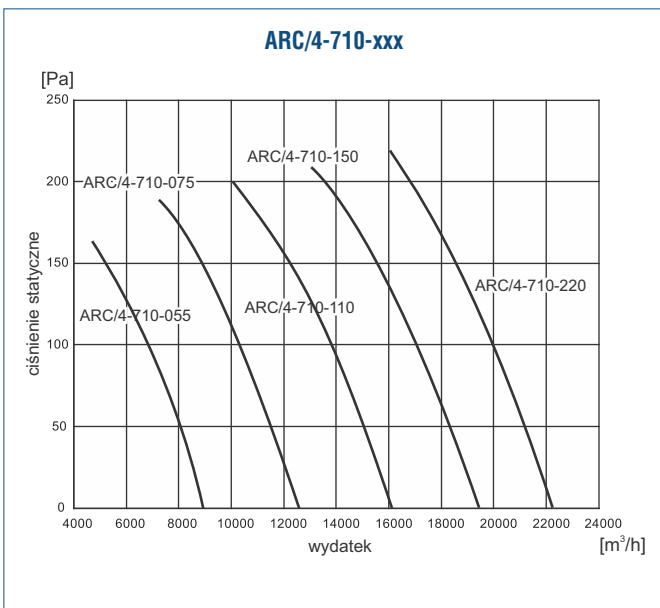
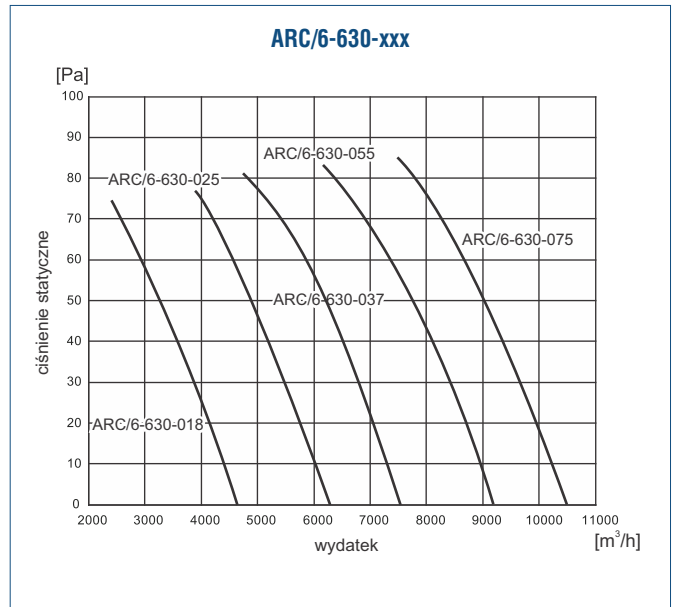
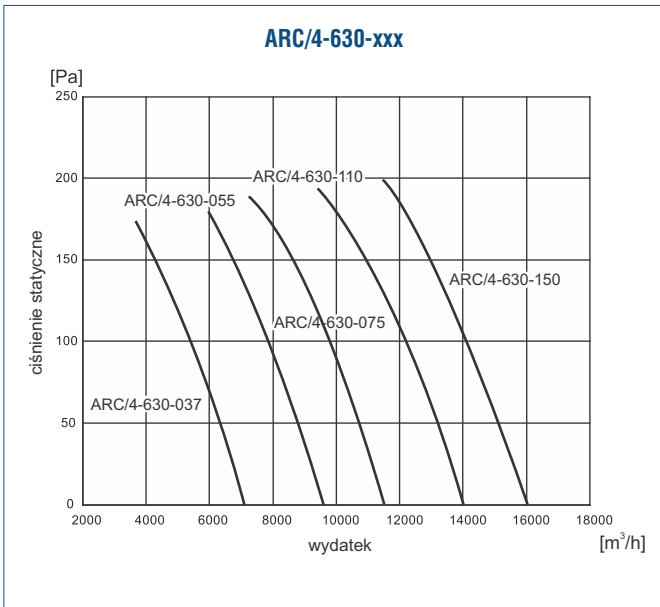
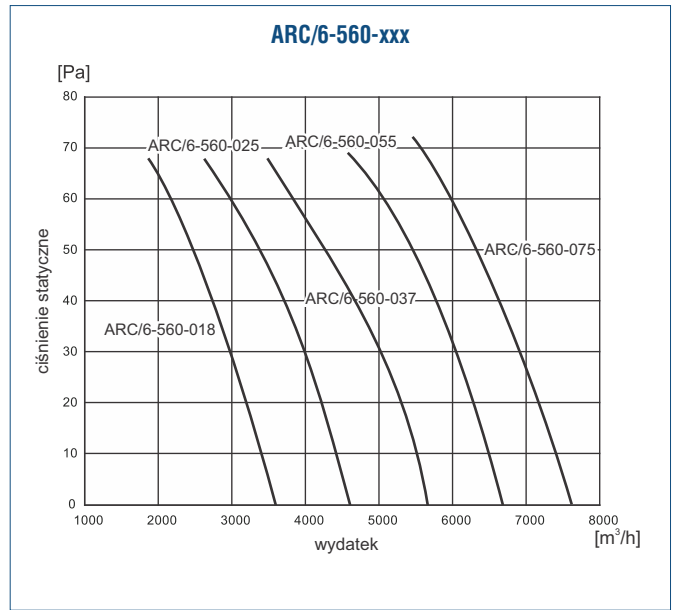
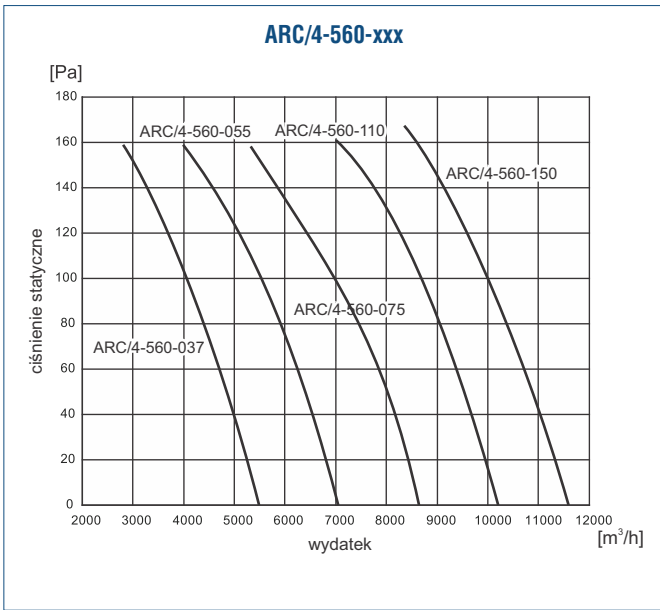

Charakterystyki pracy

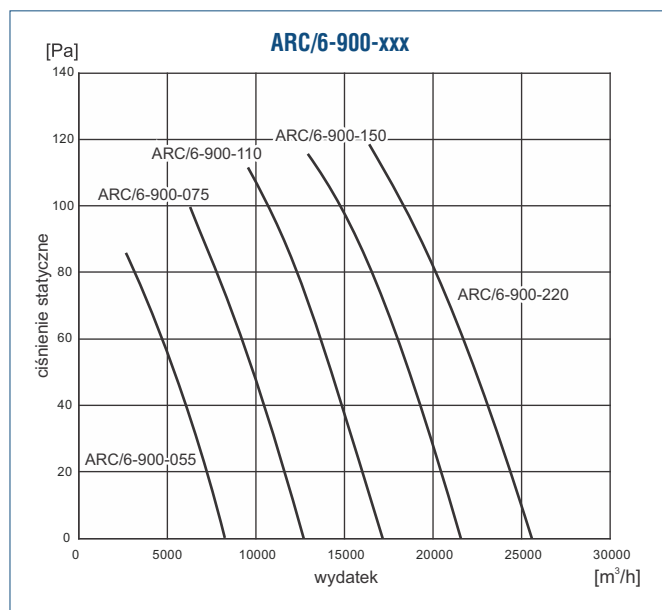
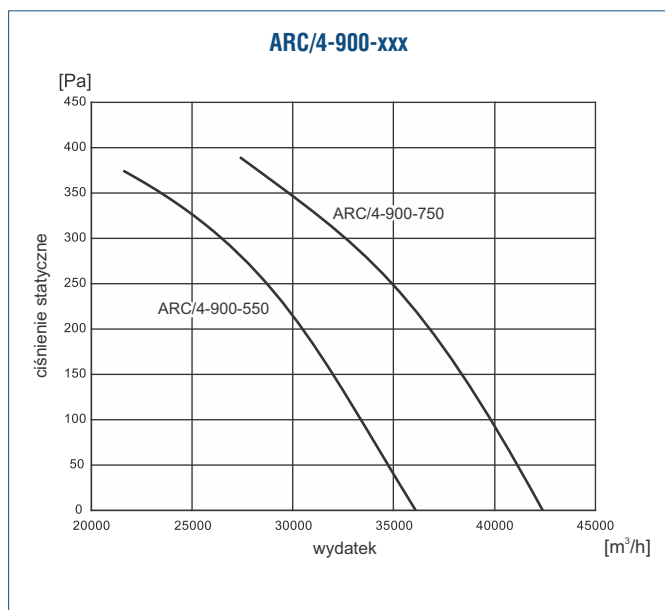
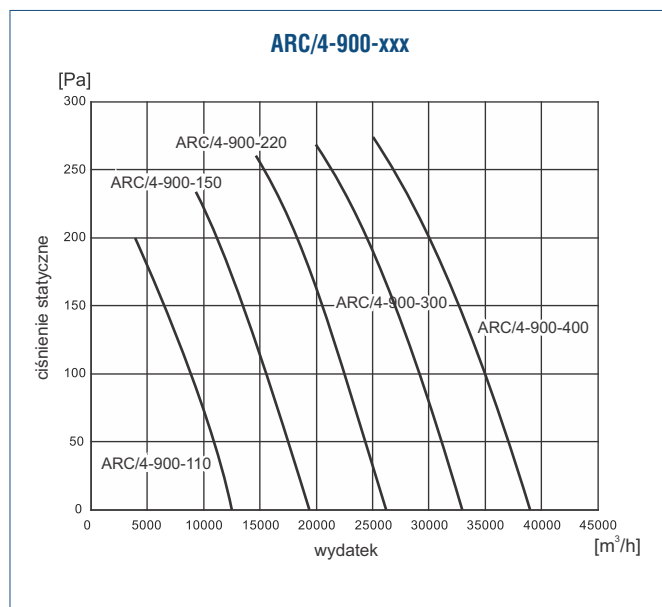
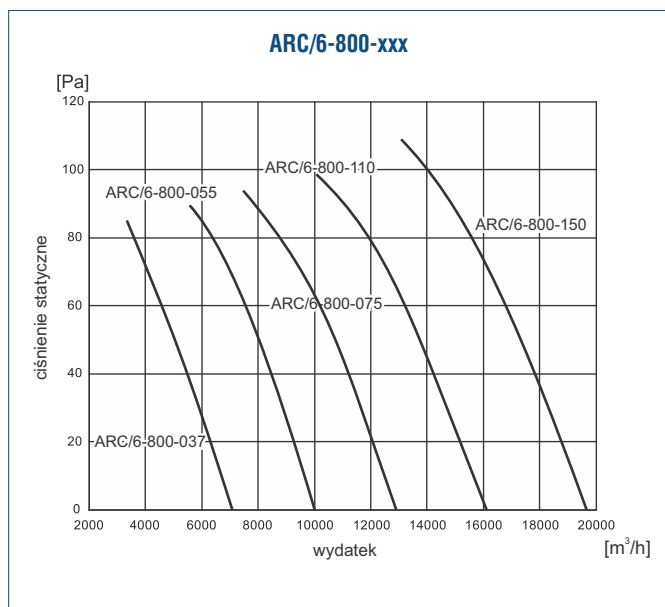
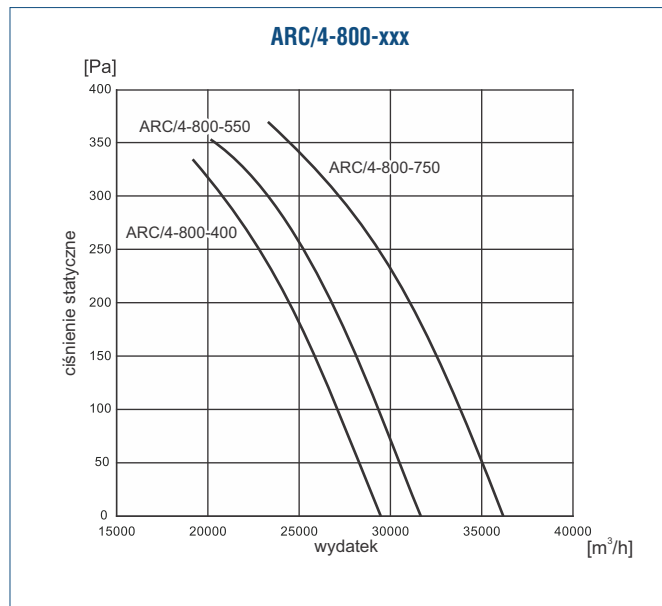
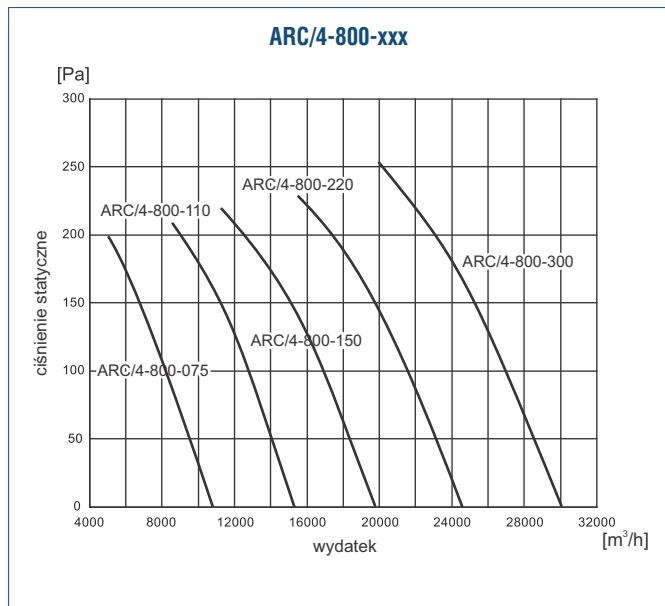

Charakterystyki pracy

